Architectural

Doors

Collection

26

VIVA®

Architectural

Doors

Collection

26

VIVA[®]

Chapter Index / Indice Capitoli

Company / Azienda	P. 2
Viva Homes	12
Products / Prodotti	107
Finishes / Finiture	251
Technicals / Schede tecniche	265

Viva 100%

made in Italy

A Company deeply rooted in its area, the furniture district north of Milan, but at the same time open and connected with the international scene, *Viva* cherishes the traditions and values of the culture of its native land.

On the strength of its long tradition and craftsmanship, *Viva* has been investing in innovation and technology to offer high-precision industrial processes, producing high-quality internal doors.

The wisdom of wood culture, matched with specific technical skills and state-of-the-art production technologies, translate into products 100% made in Italy, with custom solutions that adapt to different contexts and designing needs.

The Company commitment reflects into a catalogue full of high-quality doors, with unique technical features, that meet the taste of the international audience and the most different global trends, allowing for a high level of customization.

For *Viva*, the respect for our land is a key concept in the way we work. As we produce our doors, every design, material, and process combines technological innovation and care for our natural resources.

Our use of natural materials witnesses our commitment to protect and preserve the environment.

Our constant efforts in the selection of raw materials and suppliers and in streamlining the use of natural resources is fuelled by our desire to preserve and improve the environment for future generations.

Azienda radicata nel suo territorio, il distretto del mobile a nord di Milano, ma allo stesso tempo aperta e connessa alla scena internazionale, *Viva* conserva ancora oggi la tradizione e i valori legati alla cultura del luogo in cui nasce.

Forte della sua tradizione e del saper fare artigiano, nel tempo ha investito in innovazione e tecnologia per offrire lavorazioni industriali di alta precisione, realizzando porte interne di alta qualità.

La sapienza legata alla cultura del legno, legata alle conoscenze tecniche e alle moderne tecnologie produttive, parlano di un prodotto 100% Made in Italy, che si declina con soluzioni precise adattabili a esigenze progettuali diverse tra loro.

Una vocazione aziendale che si traduce in un catalogo composto da porte di qualità, dalle caratteristiche tecniche uniche, capaci di interpretare al meglio i gusti di un pubblico internazionale e delle più disparate tendenze globali, permettendo al cliente un elevato livello di personalizzazione.

Il rispetto del territorio è un concetto fondamentale nella filosofia di *Viva*, un approccio aziendale dove ogni progetto, materiale utilizzato e lavorazione delle porte coniugano innovazione tecnologica e attenzione alle risorse.

L'amore per i materiali naturali utilizzati rappresenta la responsabilità per garantire la tutela e la salvaguardia dell'ambiente.

L'impegno costante nella selezione delle materie prime, dei fornitori e l'ottimizzazione delle risorse naturali è volto al desiderio di preservare e migliorare le condizioni ambientali per le generazioni future.



Headquarter

and

Showroom

Viva reflects the values of Italian craft excellence in all its products and in the organisation of the company, where the headquarters serves as a hub for the realisation of projects all over the world.

The combination of experience and expertise helps set the *Viva* collections apart for their technical qualities, every raw material carefully evaluated, every process carried out with the utmost care and the final product subject to rigorous quality controls to guarantee unparalleled levels of performance over time. Painstaking attention to detail to ensure the excellence of every aspect of the product, whether visible or invisible to the naked eye. Every part of *Viva* doors boasts the master craftsmanship that only tradition and experience can guarantee.

Viva rispecchia i valori dell'eccellenza del Made in Italy in tutti i propri prodotti e nell'organizzazione aziendale, dove l'headquarter funge da hub per la realizzazione di progetti in tutto il mondo.

L'esperienza e la professionalità rendono le collezioni *Viva* caratterizzate da specificità tecniche, ogni materia prima attentamente valutata, ogni lavorazione svolta con la massima cura e il prodotto finale sottoposto a rigorosi controlli qualitativi per garantire elevate prestazioni nel tempo. Un'attenzione unica per poter offrire l'eccellenza in ogni dettaglio del prodotto, che sia visibile o invisibile all'esterno. Ogni particolare delle porte *Viva* viene curato con la maestria che solo la tradizione e l'esperienza sono in grado di offrire.



Corporate

Showroom

Milan

In the heart of Milan, *Viva* has its own space in a historic building that has been completely renovated. The strategic and prestigious location at 1 Via Visconti di Modrone underlines the company's entrepreneurial spirit and desire to establish itself on the eclectic and lively Milanese market, consolidating its standing as an international brand for the design world.

The space represents *Viva's* Milan headquarters, a meeting point for planners, architects and designers who can view a selection of products and identify the most suitable solutions for their needs together with qualified personnel.

Nel cuore di Milano *Viva* ha un proprio spazio all'interno di uno storico edificio completamente rinnovato. La strategica e prestigiosa location in via Visconti di Modrone, 1 sottolinea lo spirito imprenditoriale dell'azienda volto al posizionamento su un mercato eclettico e vivace come quello milanese, confermandosi brand internazionale per il mondo del design.

Lo spazio rappresenta l'headquarter milanese di *Viva*, un punto di incontro per progettisti, architetti e designer che potranno visionare una selezione di prodotti e studiare con personale qualificato le soluzioni più idonee alle loro esigenze.



Contract

Products “Made in Italy” are recognized around the world for their quality, elegance, exclusiveness and beauty.

Viva's products reflect all these values and every investment we make is to carry on our age-old tradition in interior design and profound knowledge of materials, workmanship and aesthetic research.

Viva contract division collaborates worldwide with architects, designers, project managers, builders and developers.

The aim is to offer dedicated solutions with a tailored management of the project and the production, in combination with the technical definition and development of the details to interpret every need of the project, both functional and aesthetic.

Il “Made in Italy” è riconosciuto nel mondo come sinonimo di qualità, eleganza, esclusività, *Viva* rispecchia questi valori in tutte le proprie porte ed ogni investimento rappresenta il proseguo di una tradizione secolare nell'arredamento e nella conoscenza dei materiali, delle lavorazioni e della ricerca estetica.

La divisione contract di *Viva* collabora con architetti, designer, progettisti, società di costruzioni e developer nel mondo.

L'obiettivo è offrire soluzioni dedicate tramite la gestione sartoriale del progetto e della produzione, in abbinamento al servizio offerto di definizione tecnica e sviluppo dei dettagli per soddisfare ogni esigenza progettuale, funzionale ed estetica.



Lagos



New York



Prague



Naples (Florida)



Milan



Toronto



Dubai



Milan



Lugano



Como lake

Viva World



Thanks to established partnerships, authorized retailers and distributors, *Viva* has been able to develop a global growth aimed at overseeing the most important national and international markets and affirming the brand.

The company is now present in 60 countries worldwide, placing itself as leader in the main markets of the world.

Viva ha saputo sviluppare una visione di crescita globale grazie a partnership ormai consolidate con rivenditori e distributori autorizzati, volta a presidiare i mercati nazionali ed internazionali più importanti e ad affermare la propria immagine.

Il brand è oggi presente in 60 nazioni nel mondo, ponendosi come leader nei principali mercati mondiali.



Viva Homes

Washington,
United States

P.16

Anversa,
Belgium

P.26

Riyadh,
Saudi Arabia

P.36

Saint Barth,
Caribbean

P.46

Como,
Italy

P.56

Tulum,
Mexico

P.66

Milan,
Italy

P.76

Tokyo,
Japan

P.86

Saint Moritz,
Switzerland

P.96

Theatrical wings

open onto the world

Door: architectural, functional and rational element. But also, an element full of meaning and symbolism, conveying a precise message depending on the context where it's designed.

A door that opens wide, toward new scenarios and new visions. A door that closes, protects, conceals, and becomes a precious ally that hides a space or that, on the contrary, opens, characterizes and makes it special.

A door can create harmony among the different rooms of a house, like an orchestra maestro who beats a tune and translates a score into a balanced, pleasant melody. A door can become protagonist, or a quiet ally, which blends with the space.

Viva doors narrate about a journey, which tells us, through eight different houses around the world, how it's possible to create very different settings: a house that transforms into a stage, theatre of the domestic landscape of the people who live in it. Enjoy your exploration.

Quinte teatrali

spalancate sul mondo

La porta: elemento architettonico, funzionale, razionale. Ma anche carico di significato, di simbologia, portatrice di un messaggio preciso a seconda del contesto in cui la si progetta.

Una porta che si spalanca, verso nuovi scenari e nuove visioni. Una porta che chiude, protegge, cela, e diviene prezioso alleato che nasconde al suo interno uno spazio o che al contrario lo apre, lo caratterizza e lo rende speciale.

La porta è capace di creare armonia tra i diversi volumi della casa, come un direttore d'orchestra che scandisce la melodia e trasforma uno spartito in una composizione di suoni equilibrata e piacevole. Una porta può divenire protagonista, o assoluto alleato silenzioso, che si confonde e si amalgama con lo spazio.

Le porte *Viva* ci raccontano un viaggio, che attraverso otto differenti case in giro per il mondo parlano di come sia possibile creare quinte sceniche molto diverse tra loro: una casa che si trasforma in palcoscenico, teatro del panorama domestico di chi la abita.

Buona esplorazione.

Washington, United States

Products

Collage Scorrevole P.212

VWall P.234

Collage Pivot P.170

Light is not merely a functional element, it is a design material.

Collage partition systems introduce a contemporary graphic language. The different glass panels engage in dialogue like pieces of an architectural composition, modulating transparency, reflections, and levels of privacy. *VWall* transforms wood into continuous architecture. It becomes the narrative structure of the space, a system that envelops and defines interiors with coherence and expressive strength.

VO Alu hinged doors affirm solidity as an aesthetic value, integrating with the wall with tailored precision and transforming the door into a fully architectural element, seamlessly connected to its surroundings.

Each door is never just a passage, it is a design tool able to define space, shape atmosphere and give form to a contemporary vision of living, modeling light, material and proportions.

P.17

Collage Scorrevole

metal bronze profile,
clear glass bronze, satin
bronze, bronze micro
cannettato
/profilo bronzo metal,
vetro trasparente
bronzo, satinato bronzo,
micro cannettato bronzo

Collage Pivot

metal bronze profile,
clear glass bronze, satin
bronze, bronze micro
cannettato
/profilo bronzo metal,
vetro trasparente
bronzo, satinato bronzo,
micro cannettato bronzo

La luce non è solo un elemento funzionale, è materia progettuale.

I sistemi divisori *Collage* introducono un linguaggio grafico contemporaneo. I vetri dialogano tra loro come tasselli di una composizione architettonica, modulando trasparenze, riflessi e livelli di privacy. Le pareti rivestite con *VWall* trasformano il legno in architettura continua. È struttura narrativa dello spazio, un sistema che avvolge e definisce gli ambienti con coerenza e forza espressiva.

Le porte a battente *VO Alu* affermano la solidità come valore estetico, integrandosi alla parete con precisione sartoriale e trasformano la porta in elemento architettonico pienamente integrato con le pareti.

Ogni porta non è mai solo passaggio, è uno strumento progettuale capace di definire lo spazio, costruire atmosfera e dare forma a una visione contemporanea dell'abitare, modellando luce, materia e proporzioni.



Collage Scorrevole
metal bronze profile,
clear glass bronze, satin
bronze, bronze micro
cannettato
/profilo bronzo metal,
vetro trasparente
bronzo, satinato bronzo,
micro cannettato bronzo

VWall
dark walnut
/noce canaletto scuro

Collage Pivot
metal bronze profile,
clear glass bronze, satin
bronze, bronze micro
cannettato
/profilo bronzo metal,
vetro trasparente
bronzo, satinato bronzo,
micro cannettato bronzo





P.20
VO Alu
metal bronze profile,
dark walnut,
/profilo bronzo metal,
noce canaletto scuro

VWall
dark walnut
/noce canaletto scuro

P.22
Collage Scorrevole
metal bronze profile,
clear glass bronze, satin
bronze, bronze micro
cannettato
/profilo bronzo metal,
vetro trasparente
bronzo, satinato bronzo,
micro cannettato bronzo





VO Alu
metal bronze profile,
custom finish,
/profilo bronzo metal,
finitura custom

detail / dettaglio
VO Alu
metal bronze profile,
custom finish,
/profilo bronzo metal,
finitura custom



Anversa,

Belgium

Products

Wood P.198

VWall P.233

VCloset P.239

Authenticity and refinement are the keywords of environments in which the sophisticated warmth of wood takes centre stage. In fact, the latter can be found in the *Wood* sliding system, in the *VWall* wall covering and in the hinged door, the first of these products acting as a eye-catching curtain that divides the entrance and living area, the second embracing the living area, creating atmospheres of refined intimacy, where a selection of furniture in natural unfinished materials and pieces embellished by the passing of time dance together on stage.

A vibrant Belgian light paints landscapes reminiscent of Flemish paintings, revealing rooms that exude intimacy: with its folding doors in smoked glass, the *VCloset* is the perfect example, embodiment of an everyday life that is only partially visible to all.

Senso di autenticità e ricercatezza sono la chiave di lettura di ambienti in cui il calore sofisticato del legno fa da padrone. Quest'ultimo si ritrova infatti nel sistema scorrevole *Wood*, nel rivestimento parietale *VWall* e nella porta battente: se il primo funge da sipario scenico tra ingresso e zona giorno, il secondo abbraccia l'ambiente living regalando atmosfere di raffinata intimità, dove la selezione di arredi dai materiali naturalmente grezzi e pezzi preziosi dal tempo danzano in scena.

Una vibrante luce belga dipinge passaggi come in quadri fiamminghi, svelando ambienti dal sapore intimo: ne è chiara espressione *VCloset*, che con le sue ante a soffietto, in vetro fumé, accoglie una quotidianità parzialmente celata.

P.27

Wood

VWall

custom wood

/ legno

al campione





Wood
custom wood
/legno
al campione



P.30
VCloset
lava profile,
reflex bronze glass
/profilo lava,
vetro reflex bronzo

P.32
Wood
custom wood
/legno
al campione





detail/dettaglio
Wood
custom wood
/legno
al campione

detail/dettaglio
V Closet
lava profile,
reflex bronze glass
/profilo lava,
vetro reflex bronzo



Riyadh,

Saudi Arabia

Products

Bellagio Battente P.132

Bellagio Pivot P.166

VCloset P.239

Openings designed to embrace dreamlike atmospheres, desert landscapes that stand out on the horizon in a light that speaks of distant mirages. The sinuous movement of the dunes returns in the soft, enveloping shapes of the timeless furniture. The warmth of sand in the use of naturally warm-toned marbles, enlivened by textural effects that divert our gaze to the *Bellagio Pivots* which, like white mobile dividers, separate the two living areas of the house.

The extra-clear satin finish of the glass guarantees privacy and reflects the spaces, making the rooms seem bigger. A series of arches create passageways that reveal valuable spaces: a home office with furniture in warm shades, characterised by the alternation of sinuous lines and formal rigour, as exemplified by the *Bellagio Hinged* door, and an environment dedicated to physical wellbeing, where the *VCloset* integrates seamlessly from both a functional and aesthetic perspective.

P.37

Bellagio Battente

champagne profile,
extraclear frosted glass
/profilo champagne,
vetro satinato extrachiaro

Aperture disegnate per accogliere atmosfere oniriche, paesaggi desertici che si stagliano all'orizzonte in una luce che evoca miraggi lontani. Il movimento sinuoso delle dune ritorna nelle forme morbide e avvolgenti degli arredi dal sapore senza tempo. Il colore caldo della sabbia nell'uso di marmi dai toni naturalmente caldi, animati dal gioco di texture che trasportano lo sguardo sulle *Bellagio Pivot*, che, come quinte mobili candide, separano i due ambienti living della casa.

La finitura del vetro satinato extrachiaro regala privacy e riflette a sua volta gli spazi ampliando percettivamente gli ambienti. Un gioco di archi disegna passaggi che svelano ambienti preziosi: un home office con arredamento dai toni caldi in palette, caratterizzati dall'alternanza tra linee sinuose e rigore formale, di cui è esemplare *Bellagio Battente*, e un ambiente dedicato al benessere fisico, dove *VCloset* si integra perfettamente a livello funzionale ed estetico.





Bellagio Pivot
champagne profile,
extraclear frosted glass
/profilo champagne,
vetro satinato extrachiaro



P.40
VCloset
champagne profile,
extraclear frosted glass
/profilo champagne,
vetro satinato extrachiaro

P.42
Bellagio Pivot
champagne profile,
extraclear frosted glass
/profilo champagne,
vetro satinato extrachiaro





detail/dettaglio
Bellagio Pivot
champagne profile,
extraclear frosted glass
/profilo champagne,
vetro satinato extrachiaro

detail/dettaglio
VCloset
champagne profile,
extraclear frosted glass
/profilo champagne,
vetro satinato extrachiaro



Saint Barth,

Caribbean

Products

Vertical Scorrevole P.208

V3 P.136

VTheca P.245

Broad and open spaces, soft lines that bring the island's identity inside the house. A warm, cozy atmosphere marks time in a slow rhythm.

Making light vibrate and welcoming dimness at the same time, three different openings define the rooms confirming the materials and the lines created by architecture.

Perfectly integrating into a volume of soft shades and sinuous shapes, *V3*, swing door coplanar to the wall with lava profiles and Light Canaletto Walnut panel, is characterized by marked geometrical details.

An elegant discretion, necessary for the bedrooms, and a touch of linearity and precision given by transoms, are granted by *Vertical Sliding* doors as well as *VTheca* for the living room, both with lava profiles and ultraclear glass.

P.47

Vertical Scorrevole

lava profile
/profilo lava

VTheca

lava profile,
ultraclear transparent glass,
internal finish sand
/profilo lava,
vetro trasparente extrachiaro,
interno sabbia

Spazi ampi e aperti, linee morbide che portano l'identità dell'isola dentro casa. Un'atmosfera calda, avvolgente, che scandisce un tempo lento.

Per far vibrare la luce e al contempo accogliere la penombra, la scelta di tre differenti aperture, capaci di descrivere gli ambienti confermando le matericità e le linee spaziali create dall'architettura.

In un volume scandito da colori tenui e forme sinuose, si integra alla perfezione *V3*, porta battente complanare alla parete con profili lava e finitura in legno Noce Canaletto chiaro, caratterizzata da decisi dettagli geometrici.

Un'elegante discrezione necessaria per la zona notte, e un tocco di linearità e rigore dato dai traversini, sono regalati da *Vertical Scorrevole* così come da *VTheca* per l'ambiente living, entrambe con profili lava e vetro trasparente extrachiaro.



V3

lava profile,
light walnut
/profilo lava,
noce canaletto
chiaro

Vertical Scorrevole

lava profile,
ultraclear transparent
glass
/profilo lava,
vetro trasparente
extrachiaro





P.50
V3
lava profile,
light walnut
/profilo lava,
noce canaletto
chiaro

P.52
Vertical Scorrevole
lava profile,
ultraclear transparent
glass
/profilo lava,
vetro trasparente
extrachiaro

V3
lava profile,
light walnut
/profilo lava,
noce canaletto chiaro





V3
lava profile,
light walnut
/profilo lava,
noce canaletto
chiaro

detail/dettaglio
Vertical Scorrevole
lava profile,
ultraclear transparent glass
/profilo lava,
vetro trasparente extrachiaro



Como,

Italy

Products

VO P.114

Cernobbio P.206

VTheca P.245

Classic and contemporary blend in environments where light is the protagonist and designs the spaces thanks to large windows that bring the gaze to dreamy landscapes.

A house that expresses the strong identity typical of the city of Como, in which sobriety, rigour, elegance, rationality harmonize with a well-kept natural context, capable of giving serenity and peace.

Here *VTheca*, a system of flush-to-wall niches with a perfect integration between wall and door, *VO*, a multifaceted flush-to-wall panel able to make the door a refined architectural element that integrates with the environment, and *Cernobbio*, a minimalist door par excellence with sliding glass doors free of profiles, are able to create plays of light that recall the reflections of the water of Lake Como.

P.57

VTheca

clear reflex glass,
lava profile,
internal finish sand
/vetro reflex chiaro,
profilo lava,
interno sabbia

VO

dark walnut
/noce canaletto scuro

Classico e contemporaneo si fondono in ambienti in cui la luce è protagonista e disegna gli spazi grazie a grandi vetrate che portano lo sguardo verso panorami sognanti.

Una casa che esprime al suo interno la forte identità tipica della città di Como, in cui sobrietà, rigore, eleganza, razionalità si armonizzano ad un contesto naturale curato, capace di donare serenità e pace.

Qui *VTheca*, sistema di nicchie rasomuro con una perfetta integrazione tra parete ed anta, *VO*, poliedrica filo muro capace di rendere la porta un elemento architettonico raffinato che si integra con l'ambiente, e *Cernobbio*, porta minimalista per eccellenza con ante scorrevoli in vetro libere da profili, sono in grado di creare giochi di luce che ricordano i riverberi dell'acqua del lago di Como.



VO
custom made
/colore personalizzato

Cernobbio
lava profile,
clear reflex glass
/profilo lava,
vetro reflex chiaro

VO
dark walnut
/noce canaletto scuro

VTheca
to be paint as the wall
/mano di fondo

VTheca
clear reflex glass,
lava profile,
internal finish sand
/vetro reflex chiaro,
profilo lava,
interno sabbia





P.60
VO
custom made
/colore personalizzato



Cernobbio
lava profile,
clear reflex glass
/profilo lava,
vetro reflex chiaro



detail/dettaglio
Cernobbio
lava profile,
clear reflex glass
/profilo lava,
vetro reflex chiaro

detail/dettaglio
VTheca
clear reflex glass,
lava profile,
internal finish sand
/vetro reflex chiaro,
profilo lava,
interno sabbia



Tulum, Mexico

Products

Bellagio Scorrevole P.208

V3 P.136

Fluid volumes. A sort of malleable architecture, in which the walls and the rhythm of the spaces are able to blur the boundary between outside and inside, creating sequences capable of fine-tuning a precise tension that expertly mixes the lime plaster of the walls, the warm terracotta on the floor, and the solid woods.

The warm and earthy tones host the *Bellagio* doors in fabric and glass, where the purity of the glass embraces the material aluminum, drawing thin frames on the wall.

Natural gold silk, made in Como, elected "UNESCO Creative City" by virtue of the unique experience linked to textile and silk processing, gives a touch of refinement, concealing the space in a delicate and sober way.

The geometric details of *V3*, coplanar hinged door to the wall with adjustable invisible hinges and magnetic lock without visible screws, are strong graphic marks on the wall.

P.67

Bellagio Scorrevole

lava profile,
reflex bronze glass
/profilo lava,
vetro reflex bronzo

Volumi fluidi. Una sorta di architettura malleabile, in cui le pareti e il ritmo degli spazi sono in grado di sfocare il confine tra esterno ed interno, creando delle sequenze capaci di mettere a punto una tensione precisa che mescola sapientemente l'intonaco a calce delle pareti, la terracotta calda a pavimento, e i legni masselli.

I toni caldi e terrosi ospitano le porte *Bellagio* in tessuto e vetro, dove la purezza del vetro abbraccia l'alluminio materico, disegnando cornici sottili a parete.

La seta oro naturale, realizzata a Como, "Città Creativa UNESCO" che ha ottenuto il riconoscimento in virtù dell'expertise unico legato alla lavorazione tessile e della seta, dona un tocco di raffinatezza, celando in modo delicato e sobrio lo spazio.

I dettagli geometrici di *V3*, porta a battente complanare alla parete con cerniere invisibili regolabili e serratura magnetica senza viti a vista, sono segni grafici decisi sulla parete.





Bellagio Scorrevole
lava profile,
reflex bronze glass
/profilo lava,
vetro reflex bronzo

Bellagio Scorrevole
lava profile,
golden silk glass
/profilo lava,
vetro seta oro



P.70
detail/dettaglio
Bellagio Scorrevole
lava profile,
golden silk glass
/profilo lava,
vetro seta oro

P.72
Bellagio Scorrevole
lava profile,
golden silk glass
/profilo lava,
vetro seta oro





V3
lava profile,
frosted reflex bronze glass
/profilo lava,
vetro reflex bronzo satinato

detail/dettaglio
Bellagio Scorrevole
lava profile,
golden silk glass
/profilo lava,
vetro seta oro

detail/dettaglio
V3
lava profile,
frosted reflex bronze glass
/profilo lava,
vetro reflex bronzo satinato



Milan,

Italy

Products

VO P.114

Como Scorrevole P.202

VSE Minima P.188

Doors *VO*, *Como Sliding*, and *VSE minima* are the protagonists and allies for a simple, classic, and elegant space, as it suits a Milanese apartment that is rooted in history but wants to live in the present.

Openings become a theatrical setting, framing the rooms, concealing, opening or protecting them depending on the scenario: *VO* — here in the *Grafica matt pearl* version — is the polyhedric frameless door perfectly integrated into the space, with a panel 60 mm thick; *Como Sliding* features lava profiles and light reflex glass, an ideal solution to create a perfect framing for the room beyond the door, with an invisible aluminum profile; *VSE minima* in matt pearl finish, enables the panel to slide along the wall, protagonist in the center of the vision, concealing the sliding device.

P.77

VO

graphic 2,
pearl matt
/grafica 2,
laccato opaco
perla

Le porte *VO*, *Como Scorrevole* e *VSE minima* sono protagoniste e complici assolute per un ambiente sobrio, classico ed elegante, come si addice ad uno spazio milanese legato alla storicità che vuole vivere nel tempo presente.

Le aperture si trasformano in quinte teatrali, in grado di incorniciare gli ambienti, di celarli, di aprirli o proteggerli a seconda dello scenario: *VO* qui nella versione opaca pantografata con finitura perla è la poliedrica filo muro perfettamente integrata con l'ambiente, con spessore dell'anta di 60 mm; *Como Scorrevole* presenta i profili lava e un vetro reflex chiaro, soluzione ideale per creare una perfetta cornice per lo spazio che si apre al di là della porta, con telaio in alluminio invisibile; *VSE minima* laccato opaco ha una finitura perla e permette lo scorrimento esterno muro dell'anta, protagonista e al centro della visione, celando così il binario di scorrimento.





V0
graphic 2,
pearl matt
/grafica 2,
laccato opaco
perla

Como Scorrevole
lava profile,
reflex chiaro
glass
/profilo lava,
vetro reflex chiaro



P.80
VSE minima
graphic 2,
pearl matt
/grafica 2,
laccato opaco
perla

P.82
VO
graphic 2,
pearl matt
/grafica 2,
laccato opaco
perla

Como Scorrevole
lava profile,
reflex chiaro
glass
/profilo lava,
vetro reflex
chiaro





V0
wallpaper
/carta da parati

detail / dettaglio
V0
wallpaper
/carta da parati



Tokyo,

Japan

Products

Como Scorrevole P.202

Como Battente P.128

Como Pivot P.162

VTheca P.245

The heart of Japanese architecture resides inside the house, from where the project starts off to develop toward the outside, in deep respect of nature.

Raw cement and spatulate mix with light wood, where *Viva* doors create perfect settings where one can clearly see the intellectual and spiritual effort for the simplification of the project and the importance of essentiality and formal pureness.

Como Hinged doors, without jambs and frames, *Como Sliding* doors, where harmonic reflections of the glass overlap with aluminum profiles creating light tricks, *Como Pivot* and *VTheca*, where the system guarantees the perfect blending between wall and panel — All of them integrate coherently with the space, minimalistic and simple, punctuated by surfaces, materials and natural colours.

P.87

Como Battente

lead profile,
smoked reflex glass
/profilo piombo,
vetro reflex fumé

VTheca

smoked glass,
lead profile,
internal finish white
/vetro fumé,
profilo piombo,
interno bianco

Il cuore delle architetture giapponesi sta proprio all'interno della casa, da cui parte il progetto per svilupparsi verso l'esterno, in pieno e profondo rispetto per la natura.

Cemento grezzo e spatolato a contrasto abbracciano il legno chiaro, dove le porte *Viva* creano perfette quinte sceniche sugli ambienti in cui è evidente lo sforzo intellettuale e spirituale volto al processo di semplificazione del progetto, che esalta l'importanza dell'essentialità e della purezza formale.

Le porte *Como Battente*, senza stipiti e coprifili, *Como Scorrevole*, dove i riflessi armoniosi del vetro si sovrappongono ai profili in alluminio creando giochi di luce, *Como Pivot* e *VTheca*, in cui il sistema garantisce una perfetta integrazione tra pareti e anta, si integrano coerentemente con lo spazio, minimalista e semplice, scandito dal ritmo delle superfici, dei materiali e colori naturali.



Como Pivot

lead profile,
smoked reflex glass
/profilo piombo,
vetro reflex fumé

Como Battente

lead profile,
smoked reflex glass
/profilo piombo,
vetro reflex fumé

VTheca

smoked glass,
lead profile,
internal finish white
/vetro fumé,
profilo piombo,
interno bianco

Como Scorrevole

lead profile,
smoked reflex glass
/profilo piombo,
vetro reflex fumé





P.90
Como Pivot
lead profile,
smoked reflex glass
/profilo piombo,
vetro reflex fumé

P.92
Como Scorrevole
lead profile,
smoked reflex glass
/profilo piombo,
vetro reflex fumé





detail/dettaglio
Como Scorrevole
lead profile,
smoked reflex glass
/profilo piombo,
vetro reflex fumé

detail/dettaglio
Como Battente
lead profile,
smoked reflex glass
/profilo piombo,
vetro reflex fumé



St. Moritz, Switzerland

Products

V1 P.142

V2 P.146

VPivot P.158

VSI P.192

Formal accuracy describes the rooms. *Viva* doors follow the spatial directions of each architectural volume, leading the look.

Ash parquet and maple ceiling, and in-between clean and rigorous walls stand out, evenly coated lime and architectural concrete embrace light.

Doors *V1/V2* with frames coplanar with the panel, and opening pulling or pushing, are linear, light, perfectly integrated with the space architectural design.

VPivot, elegant and functional, integrates with the architecture, becoming a revolving wall, and continuing the existing walls when closed.

VSI, sliding inside the walls, guarantees aesthetic uniformity and precision.

Il rigore formale descrive gli ambienti. Le porte *Viva* seguono le direttive spaziali di ogni volume architettonico, accompagnando lo sguardo.

Tra parquet in frassino e soffitto in acero, nel mezzo si stagliano pareti pulite e rigorose; calce a stesura uniforme e calcestruzzo architettonico accolgono la luce.

Le porte *V1/V2*, con profili coplanari all'anta e apertura a tirare e a spingere, sono lineari, leggere, perfettamente integrate al disegno architettonico dello spazio.

VPivot, elegante e funzionale, si integra con l'architettura diventando una parete girevole, e quando chiusa segue per continuità la parete esistente, così come la scorrevole *VSI* interno muro, che garantisce uniformità estetica e rigore progettuale.

P.97

VPivot

white matt

/laccato

bianco opaco

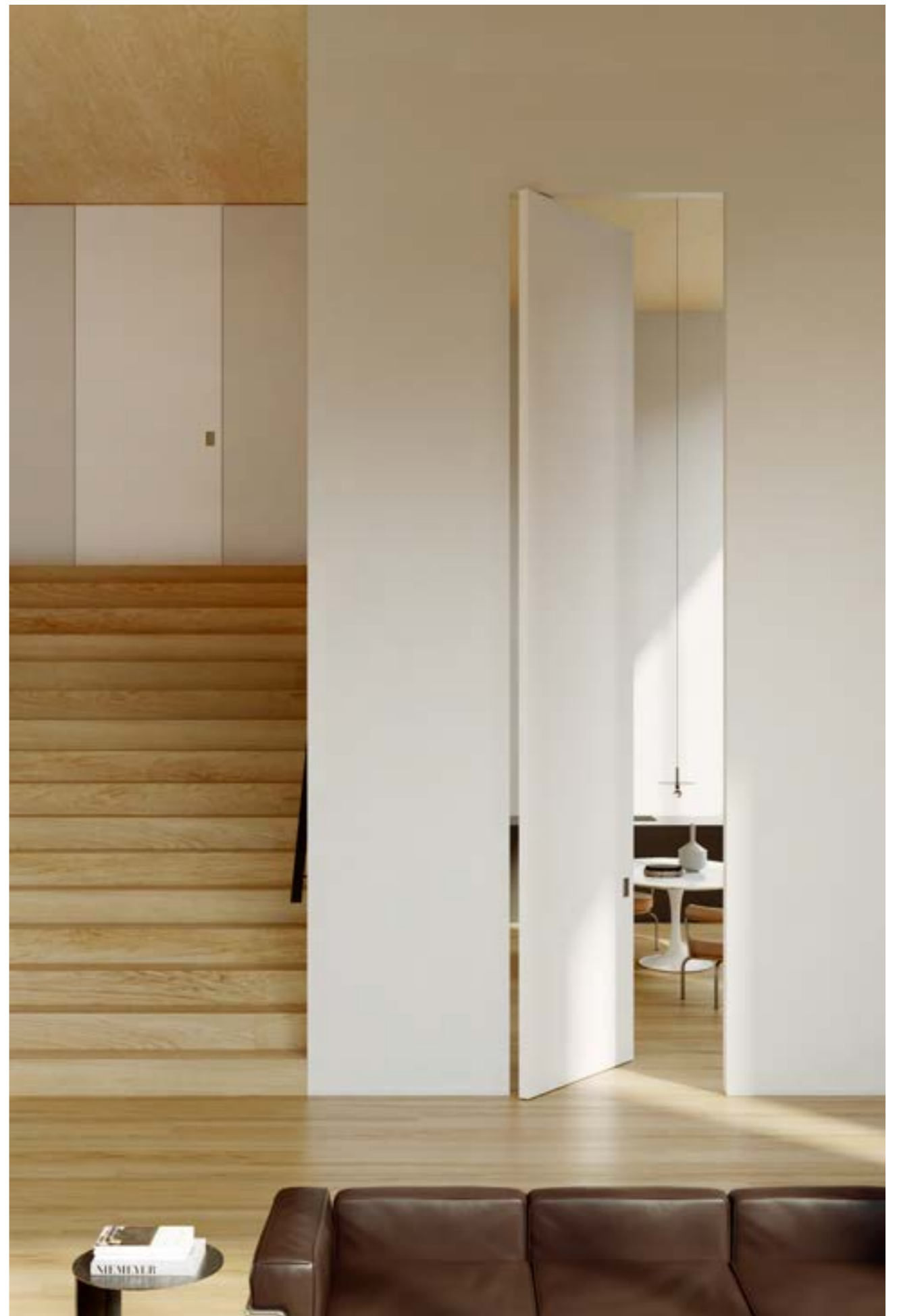

V1
white matt
/laccato
bianco opaco

V2
white matt
/laccato
bianco opaco

VPivot
white matt
/laccato
bianco opaco





P.100
V1
white matt
/laccato
bianco opaco

V2
white matt
/laccato
bianco opaco





VSI
white matt
/laccato
bianco opaco

detail/dettaglio
VPivot
white matt
/laccato
bianco opaco



Products / Prodotti

Hinged Doors / Porte Battenti	P. 111
Pivot Doors / Porte Bilico	156
Sliding Doors / Porte Scorrevoli	187
Sliding Systems / Sistemi Scorrevoli	196
VWall	233
VCloset	239
VTheca	245

Excellence / Eccellenza

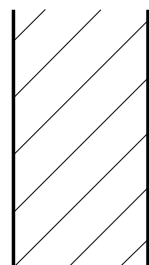

60 mm
Viva's
thickness
/spessore
anta

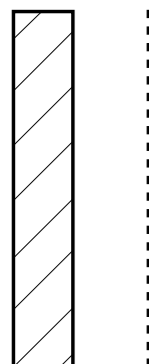

+ 40%
than standard
doors usually
in the market
/rispetto allo
spessore di una
porta tradizionale

The panel of the models *V0*, *V1*, *V2* and *V3* has a thickness of 60 mm, it is 40% higher than standard doors usually in the market. Greater thickness means solidity, stability and strength over time.

The rebate of the panel on three sides prevents the passage of light from the edge and increases the isolation of the door.

The invisible hinges, lacquered white for the white doors are adjustable to combine aesthetics and technical simplicity.

The magnetic lock without visible screws expresses the care of every single detail of *Viva* doors.

Lo spessore di 60 mm dell'anta dei modelli *V0*, *V1*, *V2* e *V3* è il 40% superiore rispetto alle porte comunemente sul mercato. Maggiore spessore indica solidità, stabilità e robustezza nel tempo.

La battuta dell'anta su tre lati evita il passaggio della luce laterale e aumenta l'isolamento della porta.

Le cerniere invisibili, laccate bianco per le porte bianche, sono regolabili per coniugare estetica e semplicità tecnica.

La serratura magnetica senza viti a vista identifica la porta *Viva* nella cura di ogni singolo dettaglio.



Hinged Doors / Porte Battenti

W/O Frames / Senza Coprifili

V0 P.114

V0 Alu P.118

V0 Arco P.122

V0C P.124

Como P.128

Bellagio P.132

V3 P.136

W/Frames / Con Coprifili

V1 P.142

V2 P.146

V1C P.150

V2C P.152

W/O Frames / Senza Coprifili

V0



P.114

V0 Alu



P.118

V0 Arco



P.122

V0C



P.124

Como

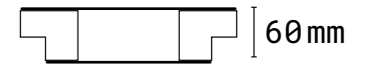
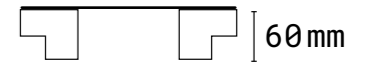
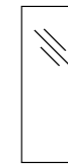

P.128

Bellagio

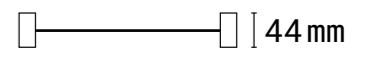

P.132

V3

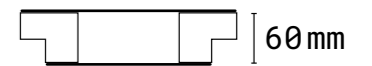
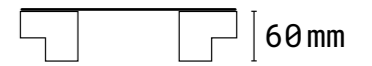
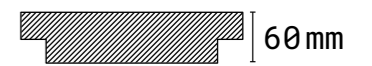
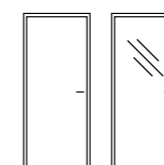

P.136

VO

Showcased in / Visibile in

Como P.56

Milan P.76

Zero is the prominence of the panel from the wall, to make the door a sober and refined architectural element, capable of interpreting and fitting into any decor, both modern and traditional.

The versatility of *VO* is given by a various range of finishes and millings, as glossy and matt lacquered colors, plain panels or with graphic effects and the *Viva Wood* finishes in real wood veneer.

VO is *Viva's* flush-to-wall door solution. Its frame can be finished like the wall, it is suitable both for drywall and for plaster, and installation is quick and easy.

Viva's research has resulted in a door with distinctive technology and quality that seems to vanish into the wall, for both the push and the pull variants, to adapt perfectly to any project requirement.

The design and technology of this door are unique: it is characterized by a panel thickness of 60 mm, with high stability and solidity, with light-tight stops on three sides, invisible adjustable hinges and magnetic lock.

Zero è la prominente dell'anta dalla parete, per rendere la porta un elemento architettonico sobrio e raffinato, capace di interpretare ed integrarsi ad ogni ambiente sia in ottica moderna che tradizionale.

La poliedricità di *VO* è data dalle molteplici finiture e lavorazioni, laccati lucidi e opachi, ante lisce e pantografate e dalle possibilità *Viva Wood* in vero legno.

VO è la soluzione porta rasomuro *Viva* con telaio rifinibile come la parete, adatto sia per il cartongesso che per l'intonaco, di rapida e semplice installazione.

La ricerca *Viva* ha prodotto una porta dalle peculiari caratteristiche tecniche e qualitative che sembra svanire nella parete sia nella soluzione a spingere che a tirare, adattandosi perfettamente ad ogni esigenza progettuale.

Una porta dalle caratteristiche di design e tecniche unica nel suo genere, caratterizzata da un pannello di spessore di 60 mm, ad elevata stabilità e solidità, con battuta su tre lati, in modo da evitare il passaggio di luce, cerniere invisibili regolabili e serratura magnetica.





VO

Alu

Showcased in / Visibile in
Washington P.16

An essential line that blends into the wall, *VO Alu* interprets the passage as a measured and contemporary architectural gesture.

The aluminum profile draws a sharp and precise perimeter along the edge of the panel, enhancing the 60 mm thickness that expresses solidity, stability, and visual continuity. Light flows across the surfaces, highlighting the balance between technical material and formal research.

The flush integration amplifies the project's purity, transforming the door into a discreet yet defining element, capable of shaping volumes and guiding the eye.

A harmonious dialogue between technology and design, where every detail contributes to creating coherent, rigorous, and refined interiors.

Segno essenziale che si fonde con la parete, *VO Alu* interpreta il passaggio come gesto architettonico misurato e contemporaneo.

Il profilo in alluminio disegna un perimetro netto e preciso sul bordo dell'anta, valorizzando lo spessore da 60 mm che esprime solidità, stabilità e continuità visiva. La luce scorre sulle superfici, esaltando l'equilibrio tra materia tecnica e ricerca formale.

L'integrazione a filo amplifica la pulizia del progetto, trasformando la porta in elemento discreto ma determinante, capace di scandire i volumi e accompagnare lo sguardo.

Un dialogo armonico tra tecnologia e design, dove ogni dettaglio contribuisce a definire ambienti coerenti, rigorosi e raffinati.





VO

Arco

The *VO Arco* model is an opening system characterized by the shape of an “arco” (meaning arch) in the upper part. It fits into the space like a furnishing element, to mark and delimit the rooms making the passage, even visually, more fluid and harmonious.

Il modello *VO Arco* è un sistema di apertura che riprende nella parte superiore la forma omonima, si inserisce nello spazio come un elemento d’arredo, per scandire e delimitare gli ambienti rendendo il passaggio, anche visivamente, più fluido e armonioso.



VOC

Zero: like the gap between the door and the wall. Flush to the wall, the *VOC* door integrates seamlessly in any environment and any stylish interior design solution. As well as its simplicity, it also stands out for its chameleon-like ability to seemingly vanish into the wall.

The jamb on three sides prevents the passage of light. The invisible hinges are adjustable and the lock is magnetic. *VOC*, with a 50 mm thick leaf, is available in lacquered white.

VOC Grafica Milano

(Image / Immagine P.126—127)

Grafica Milano represents the synthesis between classic and contemporary, an expression of elegant, sober and rational space identity that makes the door a stylish architectural element that integrates with the environment in multiple technical and aesthetic solutions.

Grafica Milano is available on *Viva* swing doors with a thickness of 50 mm models: in the frameless *VOC*, framed flushing pulling *V1C* and framed flushing pushing *V2C*.

The technical and functional requests are also completed with the availability of *Grafica Milano* for the *Viva* pocket doors with 40 mm thick panel *VS1C*, both in the version with jambs and architraves and in the more minimalist version with only the panel.

Zero come la prominenzza dell'anta dalla parete. La porta *VOC* si presenta raso muro integrandosi perfettamente in qualsiasi ambiente e per soluzioni d'arredo raffinate. Si distingue, oltre che per la sua essenzialità, per la sua veste camaleontica che sembra farla svanire nella parete.

La battuta su tre lati evita il passaggio di luce. Le cerniere invisibili sono regolabili e la serratura è magnetica. *VOC*, dall'anta dello spessore di 50 mm, è disponibile in bianco laccato.

Grafica Milano rappresenta la fusione tra classico e contemporaneo, un'espressione di identità dello spazio elegante, sobrio e razionale che rende la porta un elemento architettonico raffinato che si integra all'ambiente in molteplici soluzioni tecniche ed estetiche.

Grafica Milano è realizzabile sulle ante *Viva* a battente con spessore 50 mm: nelle versioni senza stipiti e coprifili del modello *VOC*, nelle versioni con stipite e coprifili *V1C* complanare a tirare e *V2C* complanare a spingere.

Le esigenze tecniche e funzionali si completano anche con la realizzazione di *Grafica Milano* anche per le porte scorrevoli interno muro *Viva* con anta spessore 40 mm *VS1C*, sia nella versione con stipiti e coprifili sia nella versione più minimalista con solo l'anta.





Como

Showcased in / Visibile in
Tokyo P.86

Como is the *Viva* glass swing door without jambs and frames. Developed on an invisible aluminum frame, designed by *Viva Expert Studio*, it guarantees complete integration between door and walls while maintaining aesthetic continuity both in the coplanar push opening or pull opening solution.

The glass characterizes *Como* with finesse and harmoniousness and, through games of reflections thanks to the wide types of glass available, it perfectly combines in furnishing projects both for its aesthetic and technical peculiarities.

The door can be made with single or double glass, which guarantees a thickness of the door of 60 mm, 40% higher than the common doors in the market. The glass is overlaid on the aluminum with a fascinating overlap effect.

The combination potentials of the finishes of the *Viva* collection allows the integration of *Como* with a multitude of aesthetic solutions, combining perfectly with the technical nature of the door.

Como è la porta battente in vetro *Viva* senza stipiti e coprifili. Sviluppata su un telaio in alluminio invisibile, progettata da *Viva Expert Studio*, garantisce l'integrazione completa tra porta e pareti mantenendo la continuità estetica sia nella soluzione coplanare a spingere che a tirare.

Il vetro caratterizza *Como* con finezza e armoniosità e, tramite giochi di riflessi grazie alle ampie tipologie di vetri disponibili, si coniuga alla perfezione nei progetti di arredo sia per le peculiarità estetiche che tecniche.

La porta può essere realizzata con vetro singolo o doppio, che garantisce uno spessore dell'anta di 60 mm, superiore del 40% rispetto alle porte comuni sul mercato.

Il vetro si sovrappone all'alluminio con un affascinante effetto di sormonto e le possibilità di abbinamenti delle finiture della collezione *Viva* consente l'abbinamento di *Como* con una moltitudine di soluzioni estetiche, combinandosi alla perfezione con la tecnica della porta.





Bellagio

Showcased in / Visibile in
Riyadh P.36

Designed to delineate and divide spaces with a lightness of touch while prioritising the passage of natural light and visual depth, the *Bellagio Hinged* door collection allows you to create physical continuity between rooms while respecting their functional independence.

The door with glass leaf and aluminium frame fitted directly on the finished wall blends perfectly into any environment. As well as its simplicity, it also stands out for its technical structure, which gives it a high degree of stability and solidity.

The aluminium door profiles are available in different finishes and the types of glass complement the other models in the *Bellagio* collection.

Nata per delineare e dividere gli spazi con leggerezza dando priorità al passaggio della luce naturale e alla profondità visiva, la collezione *Bellagio Battente* permette di creare continuità fisica degli ambienti, nel rispetto della loro indipendenza funzionale.

La porta con anta in vetro e stipite in alluminio installato direttamente su parete finita si integra perfettamente in qualsiasi ambiente. Si distingue, oltre che per la sua essenzialità, per la struttura tecnica che le conferisce un'elevata stabilità e solidità.

I profili in alluminio dell'anta sono disponibili in differenti finiture e le tipologie dei vetri si integrano con gli altri modelli della collezione *Bellagio*.





V3

Showcased in / Visibile in
Saint Barth P.46
Tulum P.66

V3 model comes from *Viva Expert Studio* research and project experience, a new door model with rebate that is coplanar to the wall and has no need of walled-in subframe or special set-up in construction site.

Its panel has *Viva* peculiar features: 60 mm thickness, 40% more than standard doors usually on the market; the rebate of the panel on three sides guarantees much more acoustic and visual isolation; adjustable invisible hinges and *Viva* magnetic lock without visible screws.

Jamb distinguishes V3 with easy set-up in finished wall, both brick-and plasterboard walls, and this transforms the concept of a door without frames.

The alignment to the wall is guaranteed for either pull-and push-to-open versions, the wall is separated from door jambs and this makes V3 universal and suitable for every technical and aesthetic need.

During V3 project process *Viva Expert Studio* has added the possibility to adapt the jamb to potential wall differences and its adjustability guarantees a perfect placement of the door.

Dalla ricerca ed esperienza progettuale di *Viva Expert Studio*, nasce V3, il nuovo modello di porta a battente *Viva* complanare alla parete senza la necessità di murare telai o predisposizioni speciali di cantiere.

L'anta ha le caratteristiche peculiari di *Viva*, spessore 60 mm, il 40% in più rispetto alle porte comunemente in commercio, battuta sui tre lati per garantire maggior isolamento acustico e visivo, cerniere invisibili regolabili e serratura magnetica *Viva* senza viti a vista.

Lo stipite caratterizza V3 con la semplicità di installazione su vano finito, sia in muratura che in cartongesso, rivoluzionando così il concetto di porta senza coprifili.

L'allineamento alla parete è garantito sia in versione con apertura a spingere e a tirare, il tavolato è indipendente dallo stipite della porta, rendendo V3 universale ed adatta ad ogni esigenza tecnica ed estetica.

L'esperienza di *Viva Expert Studio* ha inserito nello sviluppo di V3 la possibilità di adattare lo stipite ad eventuali difformità del vano, con una telescopicità dello stipite a garantire il perfetto inserimento della porta.





W/ Frames / Con Coprifili

V1

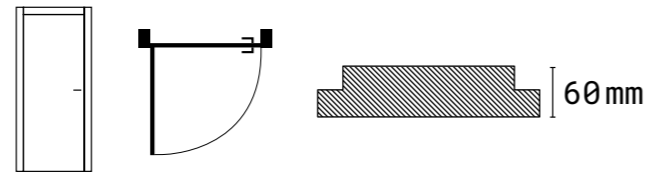

P.142

V2

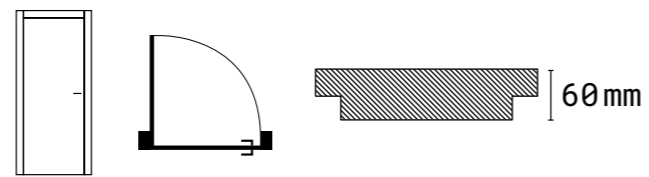

P.146

V1C

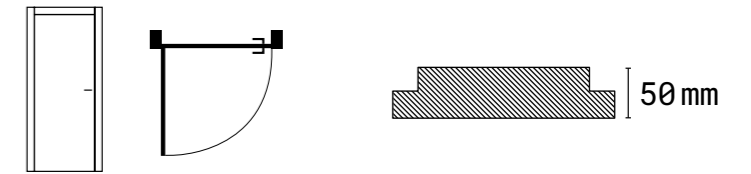

P.150

V2C



P.152

V1

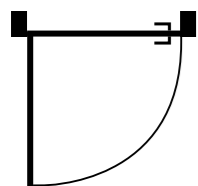

Showcased in / Visibile in St. Moritz P.96

V1 is a pull-to-open door with trims that are coplanar with the leaf.

Its looks express linearity, for a timeless door available in a range of finishes and routing designs that make it suitable for any style of furniture.

The lightness of its shapes and proportions are bound to its design: V1 is characterized by a panel thickness of 60 mm, with high stability and solidity, with light-tight stops on three sides, invisible adjustable hinges and magnetic lock.

V1 è una porta con coprifili complanari all'anta, con apertura della porta a tirare.

Le caratteristiche estetiche esprimono design e linearità, per una porta senza tempo che con le diverse finiture e possibili pantografature si adatta ad ogni stile di arredo.

La leggerezza delle linee e delle proporzioni si integrano alla formulazione progettuale, V1 è caratterizzata da un pannello di spessore di 60 mm, ad elevata stabilità e solidità, con battuta su tre lati, in modo da evitare il passaggio di luce, cerniere invisibili regolabili e serratura magnetica.





V2

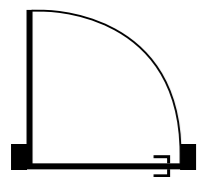

Showcased in / Visibile in
St. Moritz P.96

V2 is a push-to-open door with trims that are coplanar with the leaf. The technical solution created by Viva's research blends with the elegance and the personality of a door that expresses our distinctive seamless integration between aesthetic beauty and technological innovation. Its looks express linearity, for a timeless door available in a range of finishes and routing designs that make it suitable for any style of furniture.

The lightness of its shapes and proportions are bound to its design: V2 is characterized by a panel thickness of 60 mm, with high stability and solidity, with light-tight stops on three sides, invisible adjustable hinges and magnetic lock.

V2 è una porta con coprifili complanari all'anta, con apertura della porta a spingere. La soluzione tecnica creata dalla ricerca Viva si fonde con l'eleganza e la personalità di una porta che racchiude l'identità aziendale di perfetta integrazione tra bellezza estetica ed innovazione tecnologica.

Le caratteristiche estetiche esprimono design e linearità, per una porta senza tempo che con le diverse finiture e possibili pantografature si adatta ad ogni stile di arredo.

La leggerezza delle linee e delle proporzioni si integrano alla formulazione progettuale, V2 è caratterizzata da un pannello di spessore di 60 mm, ad elevata stabilità e solidità, con battuta su tre lati, in modo da evitare il passaggio di luce, cerniere invisibili regolabili e serratura magnetica.





V1C

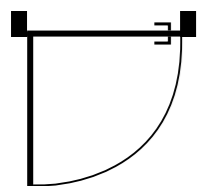

Light lines and proportions for the *V1C* system, the perfect solution in a corridor or room where seamless walls means functionality.

With rebate on three sides, invisible adjustable hinges and a magnetic lock, *V1C* is a door with flush casings and pull opening. Made with a 50 mm thick leaf, this timeless door comes lacquered white.

La leggerezza delle linee e delle proporzioni si concretizzano nel sistema *V1C*, una essenzialità perfetta in un corridoio o in una stanza dove la continuità della parete si associa alla funzionalità.

Con battuta su tre lati, cerniere invisibili regolabili e serratura magnetica, *V1C* è una porta con coprifili complanari all'anta, con apertura della porta a tirare. Realizzata con l'anta dallo spessore di 50 mm, è una porta senza tempo proposta in bianco laccato.



V2C

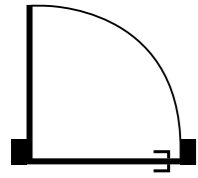

The technical features of the *V2C* ensure the door is coplanar with the leaf, with push opening. A technical solution which, combined with the elegance and personality of the door, embodies the identity of the company, which designs and produces high-impact designer systems thanks to its discerning choice of materials, attention to detail and advanced production techniques.

With rebate on three sides, invisible adjustable hinges and a magnetic lock, *V2C* suits every style and is available in lacquered white.

La versione *V2C* presenta caratteristiche tecniche proprie che permettono alla porta di essere coplanare all'anta, con apertura della porta a spingere. Una soluzione tecnica che abbinata all'eleganza e alla personalità della rappresenta l'espressione dell'identità aziendale che progetta e realizza sistemi di design dal grande valore estetico per scelta dei materiali, attenzione ai dettagli e avanzate tecniche produttive.

Con battuta su tre lati, cerniere invisibili regolabili e serratura magnetica, *V2C* si adatta a ogni stile ed è disponibile in bianco laccato.



V1C / V2C Grafica Milano

Grafica Milano represents the synthesis between classic and contemporary, an expression of elegant, sober and rational space identity that makes the door a stylish architectural element that integrates with the environment in multiple technical and aesthetic solutions.

Swing doors with *Grafica Milano* have a 50 mm panel thickness, rebate on three edges of the panel, adjustable invisible hinges and a *Viva* magnetic lock.

VOC Grafica Milano is the frameless solution that integrates perfectly into any space for sophisticated furnishing solutions, *V1C* and *V2C* are the framed solutions with the panel flush to the frame with pull and push opening respectively.

Grafica Milano rappresenta la fusione tra classico e contemporaneo, un'espressione di identità dello spazio elegante, sobrio e razionale che rende la porta un elemento architettonico raffinato che si integra all'ambiente in molteplici soluzioni tecniche ed estetiche.

Le porte a battente *Viva* con *Grafica Milano* hanno lo spessore dell'anta di 50 mm, la battuta su tre lati, cerniere invisibili regolabili e la serratura magnetica *Viva*.

VOC Grafica Milano è la soluzione senza stipiti e coprifili che si integra perfettamente in qualsiasi ambiente e per soluzioni d'arredo raffinate, *V1C* e *V2C* sono le soluzioni con stipiti e coprifili con l'anta complanare ai coprifili rispettivamente con apertura a tirare e a spingere.



Pivot Doors / Porte Bilico

V Pivot

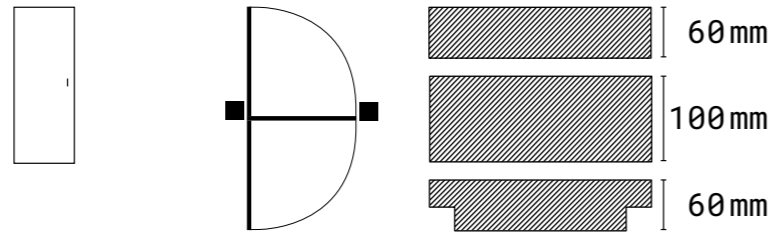

P.158

Como

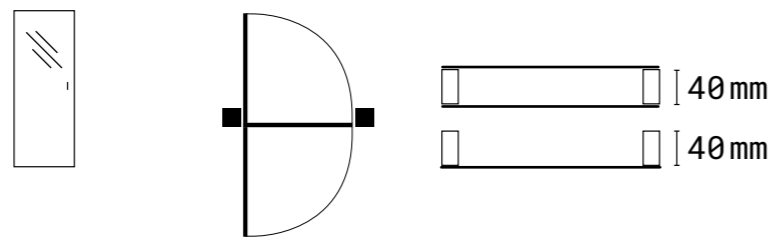

P.162

Bellagio

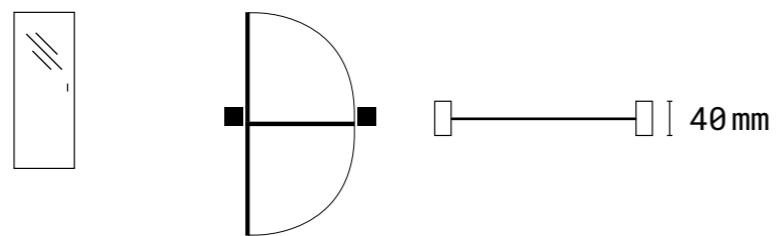

P.166

Bella

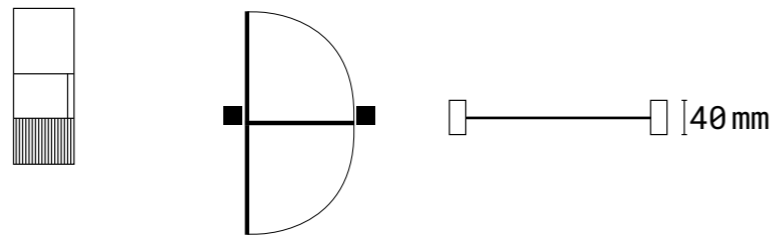

P.170

Collage

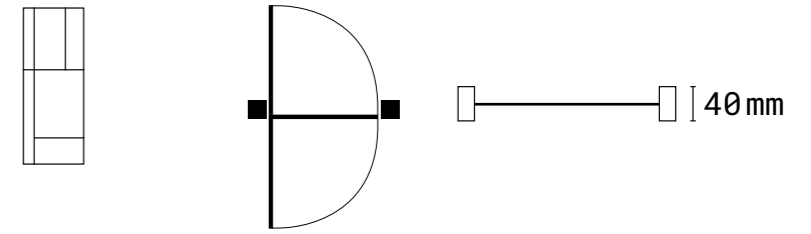

P.174

Mosaico

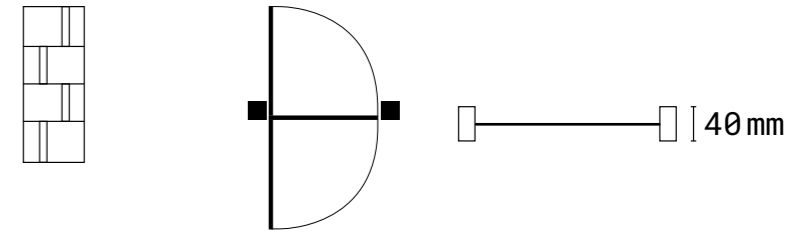

P.216

Industrial

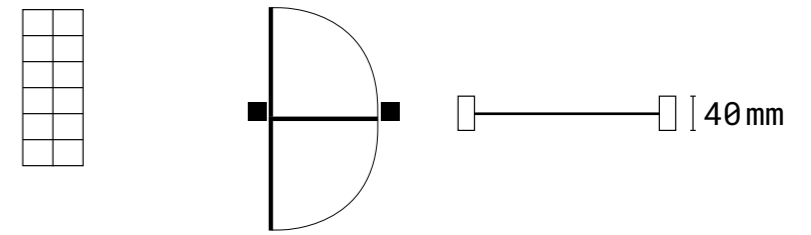

P.178

Vertical

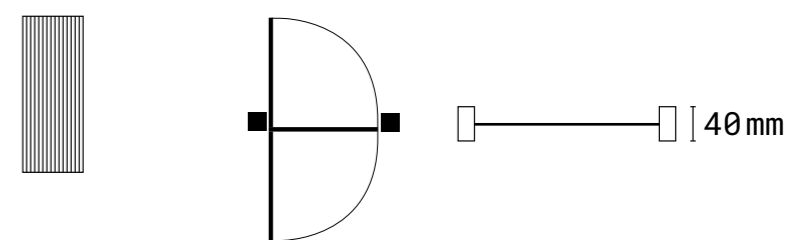

P.182

Mondrian

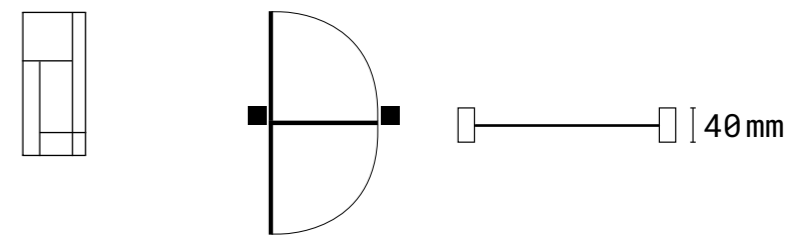

P.228

Linee

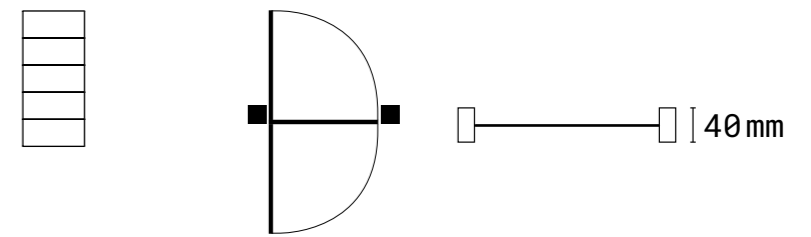

P.230

V Pivot

Showcased in / Visibile in
St. Moritz P.96

VPivot is a stylish and functional door. Equivalent to a revolving wall, when closed it integrates with continuity to the existing wall, when opened expresses its own personality, shaping the space, functionality and perception.

The panel opening and closing is on a vertical pivot, on two hidden pins placed at the ends. The door rotates on its vertical axis with a large, bright and exciting opening.

The various finishes, as glossy and matt lacquered colors, wood veneers or custom allow architects and designers to adapt the door to their project and space.

The possibilities to use *VPivot* in new or existing situations have no limits, the technical components allow to realize solutions not only during the construction but also on pre-existing and finished walls, without invasive works in the floor and in the ceiling.

The technical rotation elements are integrated inside the panel, which also ensures an easy installation.

Every aesthetic and functional detail is carefully designed to offer a unique door that enhances the space and decorates with personality.

VPivot è una porta elegante e funzionale. Equivale a una parete girevole, quando è chiusa si integra con continuità alla parete esistente, se aperta esprime tutta la propria personalità, formando lo spazio, la funzionalità e la percezione.

L'apertura e la chiusura avviene per mezzo di un bilico verticale, composto da due perni a scomparsa posti all'estremità. L'anta ruota sul proprio asse verticale con un'apertura ampia, luminosa ed emozionante.

Le molteplici finiture laccate lucide, opache, essenze lignee o custom garantiscono agli architetti e ai progettisti di adattare *VPivot* a seconda del progetto e dello spazio.

Le possibilità per l'impiego in situazioni nuove o preesistenti non hanno limiti, la componente tecnica permette di realizzare soluzioni non solo in sede di costruzione ma anche a parete finita e preesistente, con la possibilità di non avere inserimenti invasivi nel pavimento e nel soffitto.

Gli elementi tecnici di rotazione sono integrati all'interno della porta, il che garantisce anche la semplicità dell'installazione.

Ogni dettaglio estetico e funzionale è accuratamente studiato per offrire una porta unica che esalta l'ambiente e arreda con personalità.





Como

Showcased in / Visibile in
Tokyo P.86

Como collection is now completed with pivot door technology, an elegant and functional door, distinguished by glass harmonious reflections that, overlapping the aluminium frame with different finish possibilities, it creates unique and incomparable trick of the light and transparency.

The door rotates on its vertical axis with a large, bright and strong aesthetic effect opening.

The panel closing takes place on a hidden pin placed in the door thickness, making installation easier and assembly management simpler, without invasive works in the floor or in the ceiling.

Como Pivot makes every aesthetic detail a functional feature, which are accomplished in a unique door that enhances spaces and decorates with personality.

La collezione *Como* si completa con la tecnologia della porta pivot, da cui nasce una porta elegante, funzionale e caratterizzata dai riflessi armoniosi del vetro che, sovrapponendosi ai profili in alluminio, con diverse possibilità di finiture, crea giochi di luce e di trasparenza unici e inimitabili.

L'anta ruota sul proprio asse verticale con un'apertura ampia, luminosa e dal forte impatto estetico.

La chiusura avviene tramite un perno di rotazione integrato nel profilo della porta, agevolando l'installazione e semplificando la gestione del montaggio, senza interventi invasivi nel pavimento e nel soffitto.

Como Pivot rende ogni singolo dettaglio estetico funzionale che si trasmette in una porta unica, esaltando l'ambiente e arredando con personalità.





Bellagio

Showcased in / Visibile in
Riyadh P.36

Contemporary style, functionality and technology: these are the hallmarks of the *Bellagio* collection, an evocative name that recalls the magic of the enchanted town on the shores of Lake Como and which is completed with the Pivot version.

Thanks to two integrated concealed vertical pivots at either end of the leaf, it lightly rotates on its vertical axis. When opened, this mechanism creates an extended passageway that redefines and expands the room, thanks also to the purity and the transparency of the glass set in a thin aluminium frame. When the door is closed, it blends seamlessly into the wall, allowing light to pass through.

Il perfetto connubio tra stile contemporaneo, funzionalità e tecnologia è il segno distintivo della collezione *Bellagio*, nome evocativo che rimanda alla magia di quello stesso luogo incantato che si specchia nelle acque del lago di Como e che si completa con la versione Pivot.

Grazie a due perni verticali a scomparsa integrati e posti all'estremità dell'anta, ruota sul proprio asse verticale con leggerezza. In fase di apertura, questo meccanismo consente di creare un esteso passaggio che ridefinisce e amplia l'ambiente, grazie anche alla purezza e alla trasparenza del vetro definito da una sottile cornice in alluminio. Quando l'anta viene chiusa si integra in continuità alla parete, permettendo il passaggio della luce.





Bella

Transparency and materiality come together in *Bella*, where light becomes the true protagonist and the passage turns into an architectural experience.

The glass panel, framed by slim aluminum profiles, engages in dialogue with the lower textured section, introducing a bold graphic sign that creates balance between openness and privacy.

The vertical cladding adds rhythm and depth, while the glazed upper part enhances visual continuity between spaces.

Bella defines interiors with contemporary elegance, combining lightness and solidity in a harmonious composition that enhances proportions, light, and material.

Trasparenza e materia si incontrano in *Bella*, dove la luce diventa protagonista e il passaggio si trasforma in esperienza architettonica.

L'anta in vetro, scandita da profili sottili in alluminio, dialoga con il pannello inferiore materico che introduce un segno grafico deciso, capace di creare equilibrio tra apertura e protezione.

Il rivestimento verticale dona ritmo e profondità, mentre la parte vetrata amplifica la continuità visiva tra gli ambienti.

Bella definisce gli spazi con eleganza contemporanea, combinando leggerezza e solidità in una composizione armonica che valorizza proporzioni, luce e materia.





Collage

Showcased in / Visibile in
Washington P.16

Light geometries and a refined graphic rhythm define *Collage*, a pivot system that reinterprets the concept of glazed partitions with an evolved design language.

The structural transoms shape the panel as an architectural composition, allowing different types of glass to be combined within the same surface: transparencies, frosted finishes, and reflective effects interact to create depth and movement.

Light becomes a design material, filtered and modulated according to functional and aesthetic needs. *Collage* merges technical precision with compositional freedom, offering dynamic solutions capable of defining spaces with character, elegance, and visual continuity.

Geometrie leggere e ritmo grafico definiscono *Collage*, sistema pivot che reinterpreta il concetto di partizione vetrata con un linguaggio evoluto.

I traversini strutturali disegnano l'anta come una composizione architettonica, permettendo di combinare diverse tipologie di vetro all'interno della stessa superficie: trasparenze, satinature e riflessi dialogano tra loro creando profondità e movimento.

La luce diventa materia progettuale, filtrata e modulata secondo esigenze funzionali ed estetiche. *Collage* unisce precisione tecnica e libertà compositiva, offrendo soluzioni dinamiche capaci di definire gli spazi con carattere, eleganza e continuità visiva.





Industrial

Industrial interprets space with a bold and structured language, where glass and aluminum meet in a balance of rigor and transparency.

The sliding system stands out for its vertical and horizontal profiles applied to the glass surface, creating a geometric grid with a strong architectural impact.

Light is filtered and modulated, generating depth and reflections that enhance interiors without interrupting visual continuity.

Industrial thus becomes a dynamic partition, capable of separating and connecting spaces with contemporary character, technical precision, and an aesthetic inspired by metropolitan lofts reinterpreted with elegance.

Industrial interpreta lo spazio con un linguaggio deciso e strutturato, dove vetro e alluminio si incontrano in un equilibrio di rigore e trasparenza.

Il sistema scorrevole si distingue per i profili verticali e orizzontali applicati sulla superficie vetrata, che disegnano una griglia geometrica dal forte impatto architettonico.

La luce viene filtrata e modulata, creando giochi di profondità e riflessi che valorizzano gli ambienti senza interrompere la continuità visiva.

Industrial diventa così una partizione dinamica, capace di separare e connettere con carattere contemporaneo, precisione tecnica e un'estetica ispirata ai loft metropolitani reinterpretati in chiave elegante.





Vertical

Rhythm and lightness define *Vertical*, a sliding glass system that transforms the partition into a distinctive architectural feature.

The vertical profiles applied to the glass surface create a regular and refined pattern, acting as a visual filter that modulates light and privacy without interrupting spatial continuity.

The transparency of the glass engages in dialogue with the linearity of the profiles, generating depth and movement.

Vertical thus becomes an elegant and contemporary solution, capable of separating and connecting spaces with balance, technical precision, and a strong design identity.

Ritmo e leggerezza definiscono *Vertical*, sistema scorrevole a vetro che trasforma la partizione in un segno architettonico distintivo.

I profili verticali applicati sulla superficie vetrata scandiscono l'anta con una trama regolare e raffinata, creando un filtro visivo capace di modulare luce e privacy senza interrompere la continuità spaziale.

La trasparenza del vetro dialoga con la linearità dei profili, generando profondità e movimento.

Vertical diventa così una soluzione elegante e contemporanea, capace di separare e connettere gli ambienti con equilibrio, precisione tecnica e forte identità progettuale.

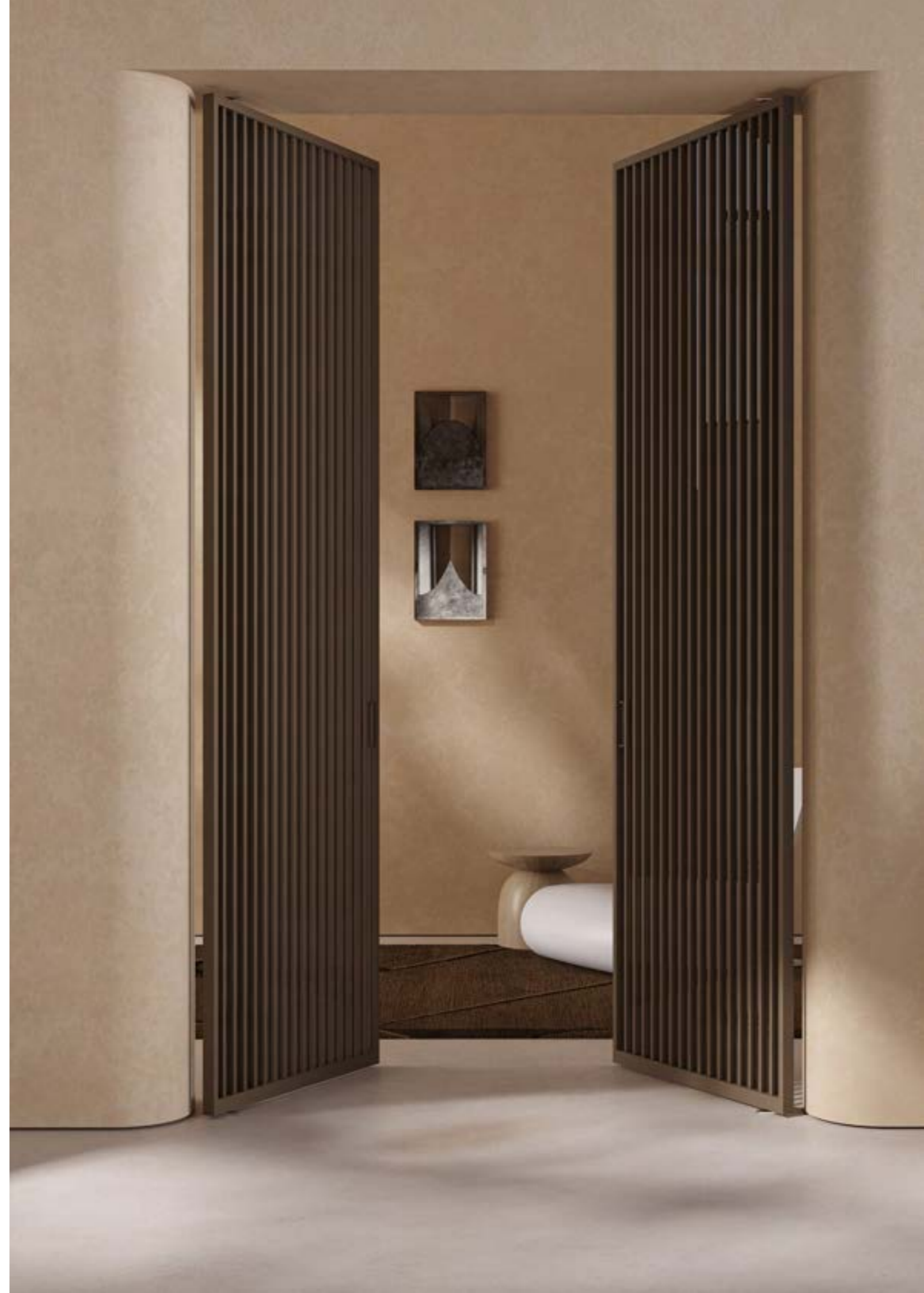



Sliding Doors / Porte Scorrevoli

**VSE
Minima**

P.188

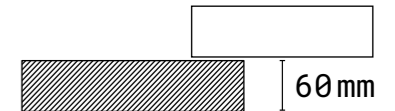

VSI

P.192

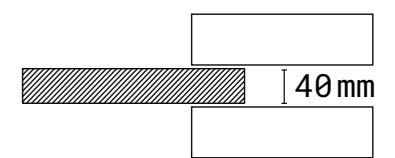

VSE

Minima

Showcased in / Visibile in
Milan P.76

VSE minima is the door with the panel that slides outside the wall, with no visible sliding track, both with door opened and closed.

The panel, of 60 mm thickness, is at the center of the vision, the technical components are hidden to focus on the aesthetic and the door personality.

It represents the combination of aesthetic and functional research to meet the needs of architects and designers, in order to obtain an harmonious result, easy installation and quality of each individual component.

The door is characterized by the slow motion system for opening and closing and there are not rails in the floor.

The final result is a door that furnishes, according to the aesthetic desires, any room where it is visible.

VSE minima permette lo scorrimento esterno muro dell'anta nascondendo alla vista il binario di scorrimento, sia con porta aperta che con porta chiusa.

L'anta, di spessore 60 mm, è al centro della visione, la componente tecnica è nascosta per massimizzare l'estetica e la personalità della porta.

Rappresenta la combinazione di ricerca estetica e funzionale per soddisfare le esigenze di architetti e progettisti, per ottenere un effetto armonioso, facilità di montaggio e qualità di ogni singolo componente.

Lo scorrimento dell'anta è caratterizzato dal sistema slow motion per avere apertura e chiusura ammortizzate e inoltre non sono presenti binari a pavimento.

È emerge una porta che arreda, a seconda dei desideri estetici, ogni ambiente in cui è presente.





VSI

Showcased in / Visibile in
St. Moritz P.96

VSI models are *Viva*'s sliding doors version that slides inside the wall adaptable to different sliding hardware solutions with jamb and frames or without frames.

Viva production flexibility and innovative technical development allow the realization of doors sliding inside the wall suitable for any requirement, adapting to the various sliding systems used worldwide, always maintaining their own personality.

VSI combines perfectly with *Viva* hinged doors models thanks to the homogeneity of the finishes to ensure aesthetic continuity.

VSI sono le porte scorrevoli di *Viva* per la versione interno muro adattabili alle differenti soluzioni di scorrimento sia con stipite e coprifili sia con la sola anta.

La flessibilità produttiva e la duttilità delle soluzioni tecniche innovative rendono queste tipologie adatte ad ogni esigenza per adattarsi ai differenti sistemi di scorrimento utilizzati nel mondo.

VSI si combina alla perfezione con le porte a battente *Viva* per completare l'arredamento di ogni ambiente grazie all'omogeneità delle finiture per garantire uniformità estetica.





Sliding Systems / Scorrevoli

Wood



P.198

Como

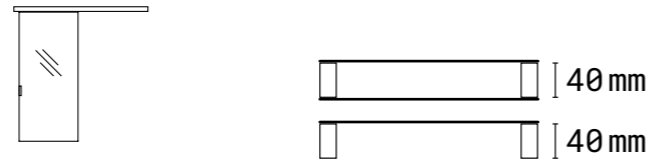

P.202

Bellagio

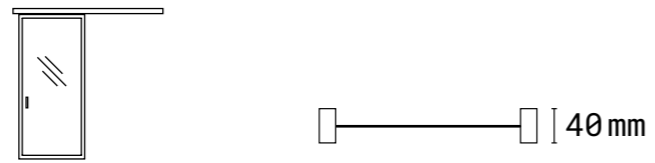

P.208

Bella

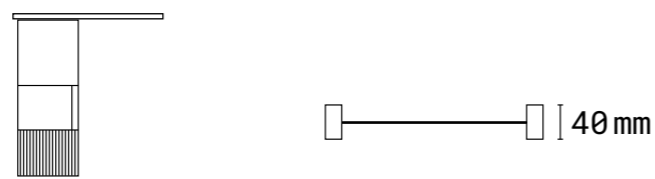

P.174

Collage

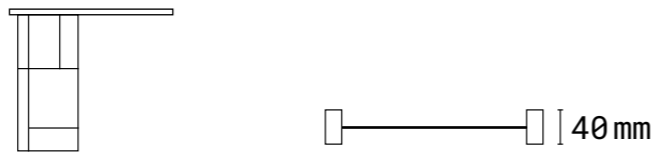

P.210

Mosaico

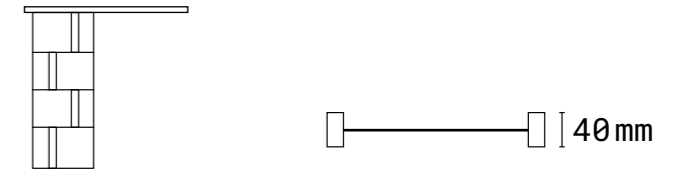

P.214

Industrial

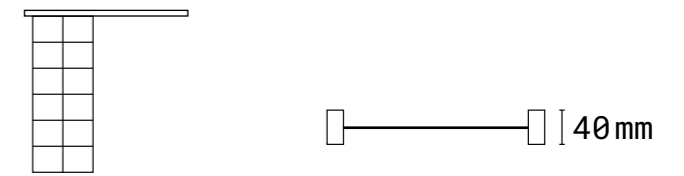

P.218

Vertical

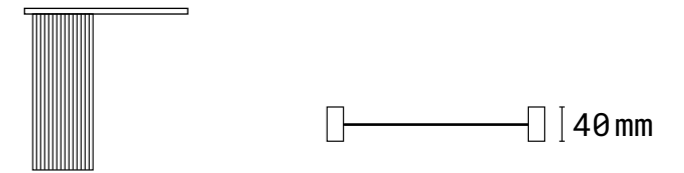

P.222

Mondrian

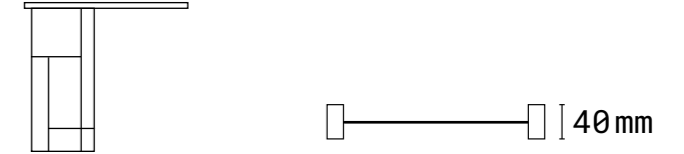

P.226

Linee

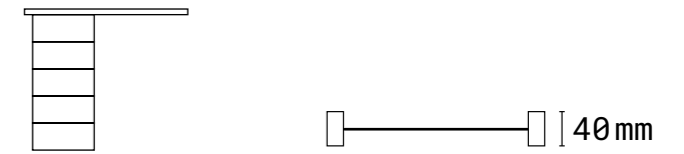

P.228

Cernobbio



P.230

Wood

Showcased in / Visibile in
Anversa P.26

The *Bellagio* collection meets the textures of wood for an interior design project of pure harmony and great beauty. The room partition is embraced by a hollow-core door, veneered in *Viva* woods or other solutions on request, also available in matt or glossy lacquer. *Wood* can be made to the millimetre to divide and separate spaces with fixed or sliding doors.

La collezione *Bellagio* incontra la matericità del legno per dare origine a un progetto di interior design di pura armonia e di grande bellezza. La partizione dell'ambiente viene abbracciata da un'anta tamburata, impiallacciata nelle essenze *Viva* o in altre soluzioni su richiesta, disponibile anche laccata opaco o lucida. *Wood* può essere realizzata al millimetro per dividere e separare spazi con ante fisse o scorrevoli.





Como

Showcased in / Visibile in

Milan P.76

Tokyo P.86

From the evolution of the glass, *Viva Expert Studio* created *Como*, a dividing system characterized by the lightness and purity of glass that meets, with elegant overlaps, the materiality of aluminum.

The shining reflections of *Como* resume the light effects of Lake Como at sunset, included in an aluminum frame underneath the glass to delineate without appearing, where lightness and elegance are emphasized.

The possibility of *Como* to have a single or double glass widens architectural and interior design solutions, combining the unique and elegant aesthetics with the technique, characterized by a track that can be easily installed to the ceiling, wall or recessed with the possibility of adjustments.

The combination of sliding doors with *Como* hinged doors is perfectly combined in a complete superior and efficient project, in line with the current needs of space and light in homes, workplaces and hospitality.

Dall'evoluzione del vetro nasce *Como*, un sistema progettato da *Viva Expert Studio* per dividere ambienti tramite la leggerezza e la purezza del vetro in un incontro con eleganti sovrapposizioni con la matericità dell'alluminio.

I lucenti riflessi che caratterizzano *Como* riprendono i giochi di luce del lago di Como al tramonto, inclusi in una cornice di alluminio sottostante al vetro per delimitare senza apparire, dove la leggerezza e l'eleganza vengono enfatizzate.

La possibilità di realizzare *Como* con vetro singolo o doppio amplia le soluzioni architettoniche e di interior design, combinando l'estetica unica ed elegante con la tecnica, caratterizzata da un binario facilmente installabile a soffitto, parete ed incasso con possibilità di regolazioni.

L'abbinamento delle porte scorrevoli con le porte a battente *Como* si combina alla perfezione in un progetto completo raffinato e funzionale, in linea con le esigenze attuali di spazio e luminosità delle abitazioni, dei luoghi di lavoro e hospitality.





Bellagio

Showcased in / Visibile in
Saint Barth P.46
Tulum P.66

Purity and transparency of glass meet the materiality of aluminium, which draws a thin frame.

Such as the views that make Bellagio unique, offering outlooks of a vivid nature which is mirrored in the lake creating sparkling reflections, so the aluminium profiles made with innovative and elegant finishes offer a new perception of the space.

With *Bellagio* sliding doors spaces maintain a physical continuity, while respecting their functional independence thanks to a minimal design solution marked by a sober decoration.

La purezza e la trasparenza del vetro incontrano la matericità dell'alluminio, che delinea una sottile cornice.

Al pari degli scorci che rendono Bellagio unica, regalando paesaggi e vedute di una natura vivida che si specchia nel lago creando luccicanti riflessi, così i profili in alluminio trattati con finiture innovative ed eleganti regalano una nuova percezione dell'ambiente in cui sono inseriti.

Con gli scorrevoli *Bellagio* gli spazi mantengono una continuità fisica, nel rispetto della loro indipendenza funzionale grazie a una soluzione progettuale minimale contraddistinta da un sobrio decoro.





Collage

Showcased in / Visibile in
Washington P.16

Light geometries and a refined graphic rhythm define *Collage*, a sliding system that reinterprets the concept of glazed partitions with an evolved design language.

The structural transoms shape the panel as an architectural composition, allowing different types of glass to be combined within the same surface: transparencies, frosted finishes, and reflective effects interact to create depth and movement.

Light becomes a design material, filtered and modulated according to functional and aesthetic needs. *Collage* merges technical precision with compositional freedom, offering dynamic solutions capable of defining spaces with character, elegance, and visual continuity.

Geometrie leggere e ritmo grafico definiscono *Collage*, sistema scorrevole che reinterpreta il concetto di partizione vetrata con un linguaggio evoluto.

I traversini strutturali disegnano l'anta come una composizione architettonica, permettendo di combinare diverse tipologie di vetro all'interno della stessa superficie: trasparenze, satinature e riflessi dialogano tra loro creando profondità e movimento.

La luce diventa materia progettuale, filtrata e modulata secondo esigenze funzionali ed estetiche. *Collage* unisce precisione tecnica e libertà compositiva, offrendo soluzioni dinamiche capaci di definire gli spazi con carattere, eleganza e continuità visiva.

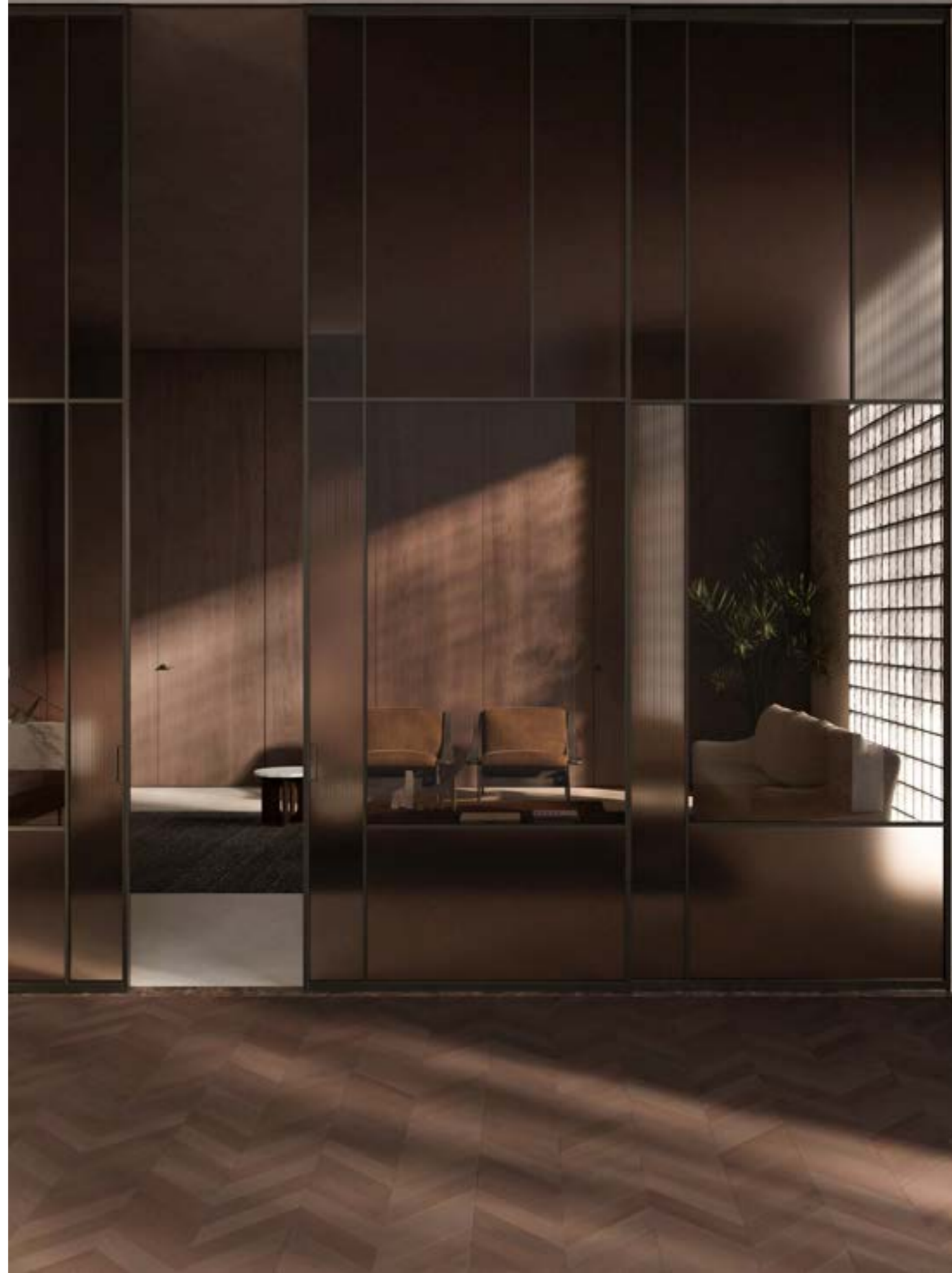



Mosaico

Mosaico is a system that interprets the partition as a graphic and material composition.

The decorations applied to the glass surface create a geometric pattern of modules, solids, and transparencies that alternate in balance, transforming the panel into a dynamic movable wall.

Light filters through the different sections, generating depth and movement, while the sliding mechanism ensures smoothness and lightness in transition.

Mosaico thus becomes a distinctive architectural element, capable of separating and connecting spaces with contemporary elegance, technical precision, and wide compositional freedom.

Mosaico è un sistema a vetro che interpreta la partizione come composizione grafica e materica.

I decori applicati sulla superficie vetrata disegnano una trama geometrica fatta di moduli, pieni e trasparenze che si alternano con equilibrio, trasformando l'anta in una parete dinamica.

La luce filtra tra le diverse campiture, creando profondità e movimento, mentre il meccanismo scorrevole garantisce fluidità e leggerezza nel passaggio.

Mosaico diventa così un elemento architettonico distintivo, capace di separare e connettere gli spazi con eleganza contemporanea, precisione tecnica e ampia libertà compositiva.





Industrial

Industrial sliding expresses a bold aesthetic, where structure becomes a true design language.

The glass is crossed by an applied metal grid that defines its surface with vertical and horizontal lines of strong graphic character.

The panel moves smoothly, transforming into a movable wall capable of redefining space with immediacy. Light is framed and modulated by the rhythm of the profiles, creating striking contrasts between transparency and materiality.

Industrial sliding is a solution conceived for contemporary interiors, where rigor, rhythm, and identity merge into an architectural balance of strong visual impact.

Industrial esprime un'estetica decisa, dove la struttura diventa linguaggio progettuale.

Il vetro è attraversato da una griglia metallica applicata, che ne scandisce la superficie con linee verticali e orizzontali dal forte carattere grafico.

L'anta si muove con fluidità, trasformandosi in una parete mobile capace di ridefinire lo spazio con immediatezza. La luce viene incorniciata e modulata dalla trama dei profili, creando suggestivi contrasti tra trasparenza e materia.

Industrial scorrevole è una soluzione pensata per ambienti contemporanei, dove rigore, ritmo e identità si fondono in un equilibrio architettonico di forte impatto.





Vertical

Showcased in / Visibile in
Saint Barth P.46

Vertical sliding interprets the partition in an essential way, entrusting the rhythm of the profiles applied to the glass with the task of defining space.

The vertical lines mark the panel with a continuous and orderly sign, creating an elegant visual filter that accompanies light without obstructing it.

The smooth movement of the system enhances the perception of lightness, transforming the door into a movable wall capable of naturally redefining interiors.

Vertical thus becomes a contemporary architectural solution in which linearity, proportion, and technical precision merge to create coherent and harmonious spaces.

Vertical scorrevole interpreta la partizione in chiave essenziale, affidando al ritmo dei profili applicati sul vetro il compito di definire lo spazio.

Le linee verticali scandiscono l'anta con un segno continuo e ordinato, creando un filtro visivo elegante che accompagna la luce senza ostacolarla.

Il movimento fluido del sistema amplifica la percezione di leggerezza, trasformando la porta in una parete mobile capace di ridefinire gli ambienti con naturalezza.

Vertical diventa così una soluzione architettonica contemporanea, in cui linearità, proporzione e precisione tecnica si fondono per creare spazi coerenti e armonici.





Mondrian

Mondrian is a glass system that transforms the partition into an architectural graphic statement.

The decorations applied to the glass create a grid of vertical and horizontal lines, forming a balanced composition between structure and transparency. The panel becomes a movable wall with strong character, capable of shaping space through rhythm and proportion.

Light flows through the different sections, generating depth and enhancing views like a sequence of framed scenes.

Available in sliding or fixed versions, *Mondrian* combines technical precision and visual lightness, defining contemporary interiors with elegance and a distinctive design identity.

Mondrian è un sistema a vetro che trasforma la partizione in un segno grafico architettonico.

I decori applicati sul vetro disegnano una griglia di linee verticali e orizzontali, creando una composizione equilibrata tra struttura e trasparenza. L'anta diventa una parete mobile dal forte carattere, capace di scandire lo spazio con ritmo e proporzione.

La luce attraversa le campiture, generando profondità e valorizzando le viste come in una sequenza di quadri.

Disponibile in versione pivot, scorrevole o fissa, *Mondrian* unisce precisione tecnica e leggerezza visiva, definendo ambienti contemporanei con eleganza e identità progettuale.



Linee

Bellagio Collection is enriched with *Linee*, a metamorphosis of modern elegance with thin aluminum profiles which, applied directly to the glass, create sophisticated and unique geometries, transforming every space into a place of refined beauty.

The lightness of glass, combined with the strength of aluminum, creates a perfect balance between transparency and design, giving brightness and an uncompromising sense of openness. Each space partition thus becomes not only a functional element but also a piece of art.

La *Collezione Bellagio* si arricchisce con *Linee*, metamorfosi dell'eleganza moderna con sottili profili in alluminio che, applicati direttamente sul vetro, danno vita a geometrie sofisticate e uniche, trasformando ogni ambiente in un luogo di raffinata bellezza.

La leggerezza del vetro, unita alla solidità dell'alluminio, crea un perfetto equilibrio tra trasparenza e design, donando luminosità e un senso di apertura senza compromessi. Ogni partizione d'ambiente diventa così non solo un elemento funzionale, ma anche un'opera d'arte.

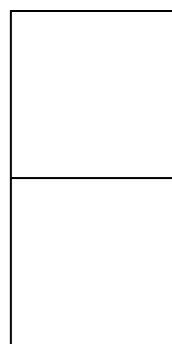

1 line
/ linea

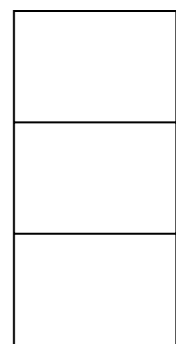

2 lines
/ linee

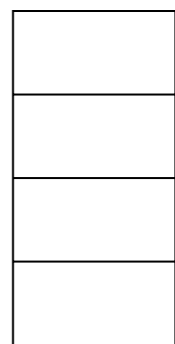

3 lines
/ linee

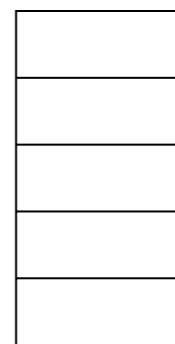

4 lines
/ linee

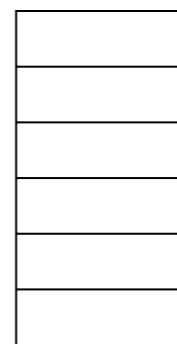

5 lines
/ linee



Cernobbio

Showcased in / Visibile in
Como P.56

Cernobbio represents minimalism "par excellence". The sliding glass doors are free from profiles for a limitless visual performance in an interplay of light and shade that recalls the charm of the natural landscapes of lake Como. Different rooms combine while maintaining their specific functions separated.

Thus, an elegant and functional project aimed at giving width and brightness to living and work places, hotels and spas common areas, was born.

Cernobbio rappresenta il minimalismo per eccellenza. Le ante scorrevoli in vetro sono libere da profili per una resa visiva senza limiti, in un gioco di luci e ombre che ricorda le suggestioni dei paesaggi naturali del lago di Como. Gli ambienti si uniscono pur mantenendo separate le funzioni a cui sono preposti.

Nasce così un progetto elegante e funzionale, in linea con le esigenze di dare ampiezza, luminosità a spazi abitativi, luoghi di lavoro, zone comuni di alberghi e centri benessere.



V Wall

VWall

Showcased in / Visibile in
Washington P.16
Anversa P.26

VWall is a system designed to optimise spaces without structural constraints. The installation of fixed *VWall* modular walls is completed with swinging doors to guarantee maximum flexibility and create customised solutions.

The resulting system makes it possible to combine fixed and openable walls, creating spaces that do not yet exist: in fact, *VWall* is composed of modular walls made to the millimetre. The *VWall* system can also reach a height of 5 metres, while the width measurement is unlimited.

VWall è un sistema ideato per ottimizzare gli spazi senza vincoli strutturali. L'integrazione di pareti fisse modulari *VWall* si completa con le aperture del modello *VPivot*, garantendo così massima flessibilità per realizzare soluzioni customizzate.

Il sistema così concepito permette di combinare pareti fisse e apribili creando spazi ancora non presenti: *VWall* è infatti composto da pareti modulari realizzate al millimetro. Il sistema *VWall* può inoltre raggiungere l'altezza di 5 metri, mentre la misura della larghezza è senza limiti.





V Closet

V Closet

Showcased in / Visibile in
Anversa P.26
Riyadh P.36

Formal research and the study of new designer solutions meets functionality in *VCloset*. Consisting of two or more panels, it is designed to meet various closet requirements and elegantly modulate contained spaces - such as niches, walk-in wardrobes, storage rooms - with an elegant and striking glass, wood or lacquered partition system that can be installed directly on the finished wall.

The glass, in different finishes, adds lightness and delicately veils the interior, while the aluminium frame emphasises the rigour of the forms. The wooden or lacquered doors conceal what lies beyond, ensuring maximum privacy.

VCloset, flush with the wall, is a clean, high-quality model with a strong aesthetic impact. The folding doors, also available as hinged doors, is a technical feature that creates movement and saves space.

La ricerca formale e lo studio di nuove soluzioni di design incontrano la funzionalità in *VCloset*. Composta da due o più ante, è nata per rispondere alle diverse esigenze di chiudere e modulare con raffinatezza spazi contenuti — come nicchie, cabine armadio, ripostigli — con un sistema divisorio in vetro, legno o laccato, dell'estetica unica ed elegante installabile direttamente su parete finita.

Il vetro, in diverse finiture, dona leggerezza e vela con delicatezza l'interno, mentre il telaio in alluminio esalta il rigore delle forme. Le ante in legno o laccato, nascondono ciò che si trova oltre, per il massimo della privacy.

VCloset, complanare alla parete, è un modello pulito con un'elevata connotazione estetica e di alta qualità. La chiusura a libro delle ante, disponibili anche a battente, rappresenta una particolarità tecnica che crea movimento e permette di recuperare spazio.





VTheca

VTheca

Showcased in / Visibile in
Saint Barth P.46

Como P.56

Tokyo P.86

VTheca is the flush-to-wall opening system with strong aesthetic personality. Installed on a concealable aluminum frame, the system guarantees perfect integration between walls and panel.

The aluminum frame has been developed to ensure perfect application and duration over time. Once it is built in the plasterboard wall, it appears invisible.

VTheca is supplied complete of container box and made with measures at the centimeter, characteristics that guarantee easy installation and great adaptability.

The multiple finishes of the panels let them adapt to any aesthetic solution.

VTheca has invisible hinges and push-pull opening system, thus ensuring the perfect union between technique and aesthetic.

The opportunity to install the panels with bottom hinged, top hung or hinged opening let *VTheca* integrate perfectly in every room, and consent to create space where it doesn't exist.

VTheca è un sistema di aperture raso muro dalla spiccata personalità estetica. Installata su un telaio in alluminio a scomparsa, il sistema garantisce una perfetta integrazione tra pareti e anta.

Il telaio sviluppato per assicurare perfezione di applicazione e durata nel tempo, e una volta murato nella parete in cartongesso risulta invisibile.

VTheca viene fornita completa di contenitore e realizzata con misure al centimetro, caratteristiche che garantiscono facilità di installazione e grande adattabilità.

Le molteplici finiture delle ante permettono di adattare a qualsiasi soluzione estetica.

VTheca è dotata di cerniere invisibili e apertura push-pull, assicurando così il perfetto connubio tra tecnica ed estetica.

La possibilità di installare le ante con apertura a ribalta o a battente consente a *VTheca* di integrarsi perfettamente in qualsiasi stanza, permettendo di creare spazio anche dove non esiste.





Finishes / Finiture

Lacquers / Laccati

Viva continually focuses on research, analysis and selection of trendy finishes around the world, implementing international tastes and integrating them into a range of door finishes that gives each *Viva* product its own characteristics and personality, to suit any taste and lifestyle.

The finishes made by *Viva* enhance the high qualitative content of the doors, both visible and intrinsic, perfectly fitting in with the different types of interior decor, thanks to flexible colour solutions that match with any setting.

Viva dedica una continua attenzione alla ricerca, valutazione e selezione delle finiture di tendenza a livello globale, recependo i gusti internazionali ed elaborandoli in una scelta di finiture per le porte in grado di conferire ai prodotti *Viva* caratteristiche e personalità differenti, per soddisfare ogni gusto estetico e stile di vita.

Le finiture realizzate da *Viva* amplificano l'elevato contenuto qualitativo delle porte, sia esteriore che intrinseco, integrandosi alla perfezione con le diverse tipologie d'arredo, grazie a soluzioni cromatiche flessibili e armoniose con ogni ambiente.

Lacquers glossy and matt / Laccati lucidi e opachi



* New Finishes 2026 / Nuove Finiture 2026

Wood

The choices of *Viva Wood* collection transmit the culture and tradition of wood, recalling the craftsmanship of master craftsmen, integrating with design studies and innovative research techniques.

The specificity and warmth of the wood grain creates a natural elegance that transforms a piece of furniture in a journey of the senses.

The selection of veneers, the natural movement of the wood and the unique shades make unique each project and the love for natural materials is the responsibility to ensure the protection of the environment.

Le finiture *Viva Wood* trasmettono la cultura e la tradizione del legno, richiamando la manualità dei maestri artigiani, integrandole con studi di design e ricerche tecniche innovative.

La specificità, la tattilità e il calore delle venature del legno creano un'eleganza naturale che trasforma un complemento d'arredo in un viaggio nei sensi.

La selezione di legni naturali *Viva*, il movimento naturale del legno e le sfumature uniche rendono ogni progetto inimitabile e l'amore per i materiali naturali utilizzati rappresenta la responsabilità per garantire la tutela dell'ambiente.

Wood veneers for / Legni per V0, V Pivot, V3, VSI, VSE

For VSI only door, no jamb / Per VSI solo anta, no stipite



* New Finishes 2026 / Nuove Finiture 2026

Como

Glass/Vetri



Aluminum profiles/Profili alluminio

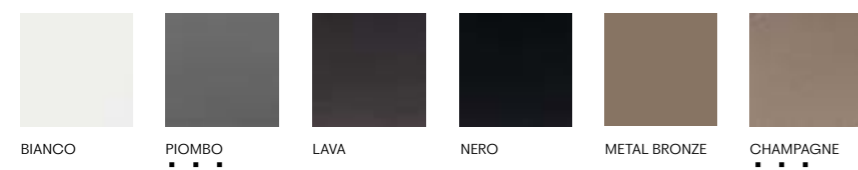

- Only for *Como* single glass/Solo per *Como* vetro singolo
- Only for *Como* double glass/Solo per *Como* vetro doppio
- Solo per scorrevole e pivot / Only for sliding and pivot

V3

Glass/Vetri

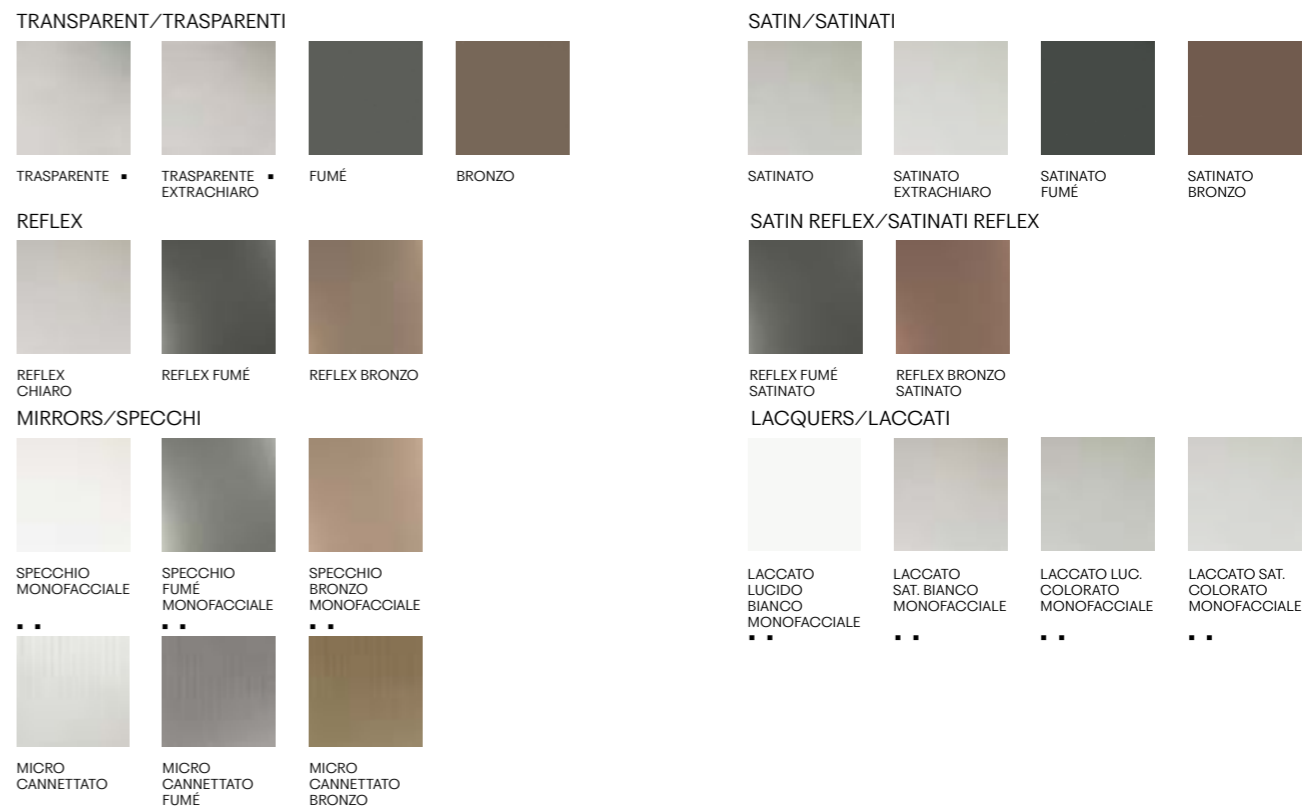

Aluminum profiles/Profili alluminio

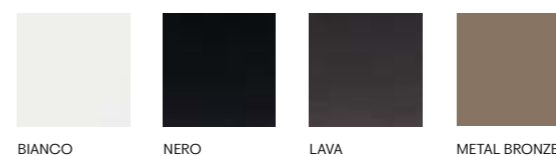

- Only for *V3* single glass/Solo per *V3* vetro singolo
- Only for *V3* double glass/Solo per *V3* vetro doppio

Bellagio

Bella

Collage

Mosaico

Industrial

Vertical

Mondrian

Linee

Glass/Vetri

TRANSPARENT/TRASPARENTI



TRASPARENTE TRASPARENTE EXTRACHIARO FUMÉ BRONZO

REFLEX



REFLEX CHIARO REFLEX FUMÉ REFLEX BRONZO

MIRRORS/SPECCHI



BIFACCIALE FUMÉ BRONZO

MATERIAL GLASSES/VETRI MATERICI

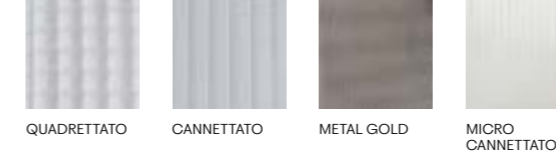

QUADRETTATO CANNETTATO METAL GOLD MICRO CANNETTATO

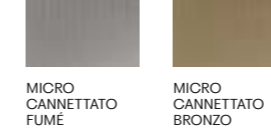

MICRO CANNETTATO FUMÉ MICRO CANNETTATO BRONZO

SATIN/SATINATI



SATINATO SATINATO EXTRACHIARO SATINATO FUMÉ SATINATO BRONZO

SATIN REFLEX/SATINATI REFLEX

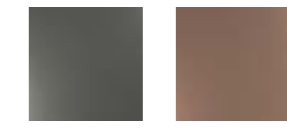

REFLEX FUMÉ SATINATO REFLEX BRONZO SATINATO

FABRICS/TESSUTI



LINO BIANCO LINO NATURAL LINO BROWN

LACQUERS/LACCATI



LACCATO LUCIDO BIANCO BIFACCIALE LACCATO SAT. BIANCO BIFACCIALE LACCATO LUC. COLORATO BIFACCIALE LACCATO SAT. COLORATO BIFACCIALE

Aluminum profiles/Profili alluminio



BIANCO PIOMBO LAVA NERO METAL BRONZE CHAMPAGNE

WOOD / LEGNI



ROVERE SCURO ROVERE CHIARO NOCE CANALETTO SCURO

▪ Not available for structural transoms *Collage*
/Non disponibili per traversini strutturali *Collage*

Bellagio

Bella

Collage

Mosaico

Industrial

Vertical

Mondrian

Linee

Cernobbio

Possible compositions/Possibili composizioni

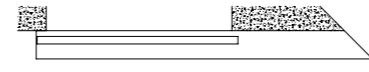

1 Panel / Anta

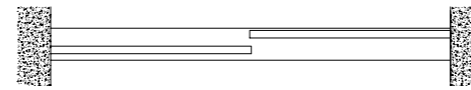

2 Panels / Ante

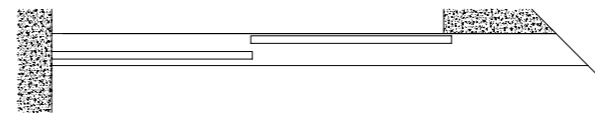

2 Panels / Ante

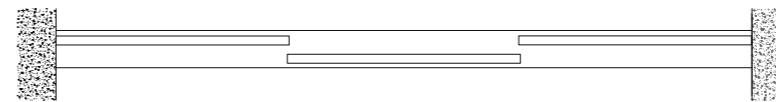

3 Panels / Ante

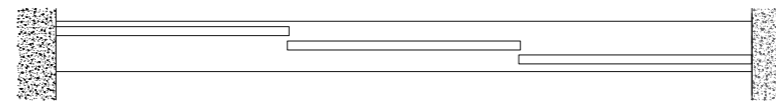

3 Panels / Ante

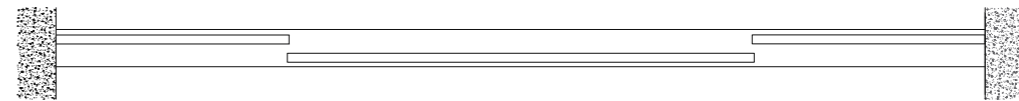

4 Panels / Ante

Handles/Maniglie



Dimensions in mm/Dimensioni in mm

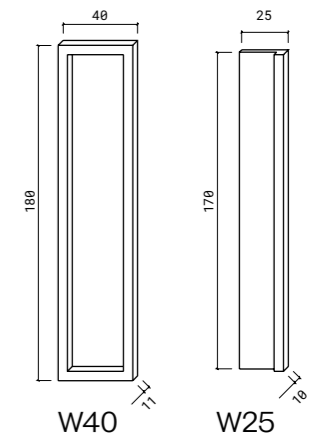

Cernobbio

Glass/Vetri

TRANSPARENT/TRASPARENTI



TRASPARENTE TRASPARENTE EXTRACHIAIRO FUMÉ BRONZO

LACQUERS/LACCATI



LACCATO LUCIDO BIANCO BIFACCIALE LACCATO SAT. BIANCO BIFACCIALE LACCATO LUC. COLORATO BIFACCIALE LACCATO SAT. COLORATO BIFACCIALE

SATIN/SATINATI



SATINATO SATINATO EXTRACHIAIRO SATINATO FUMÉ SATINATO BRONZO

Aluminum profiles/Profili alluminio



BIANCO PIOMBO LAVA NERO METAL BRONZE CHAMPAGNE

VTheca, V Closet

The multiple finishes of glass, together with the possibility of different compositions, make *VTheca* a refined and distinctive element that doesn't go unnoticed.

Le molteplici finiture di vetri, unite alla possibilità di diversi tipi di composizione, rendono *VTheca* un elemento ricercato e distintivo che non passa inosservato.

Aluminum profiles/Profili alluminio



BIANCO PIOMBO LAVA

Glass/Vetri



TRASPARENTE SATINATO TRASPARENTE EXTRACHIAIRO FUMÉ REFLEX FUMÉ BRONZO SPECCHIO FUMÉ REFLEX BRONZO SATINATO EXTRACHIAIRO



SATINATO FUMÉ SATINATO BRONZO REFLEX CHIARO SPECCHIO MONOFACCIALE SPECCHIO BRONZO MICRO CANNETTATO MICRO CANNETTATO FUMÉ MICRO CANNETTATO BRONZO

Lacquers matt /Laccati opachi



TO BE PAINTED /MANO DI FONDO BIANCO

Interior for VTheca /Interni per VTheca



BIANCO SABBIA ARGILLA

Lock covers / Copri serratura



CROMO LUCIDO



CROMO SATINATO



ANTRACITE



NERO



OTTONE



BIANCO

Graphic / Grafica

Lacquers glossy and matt / Laccati lucidi e opachi

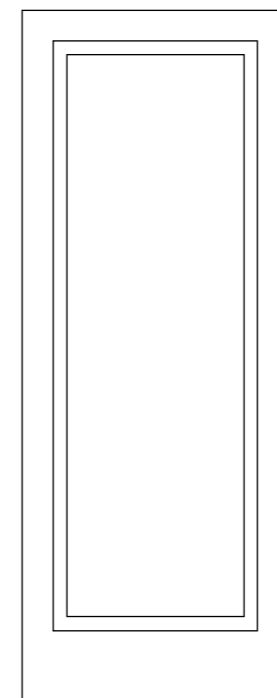

1

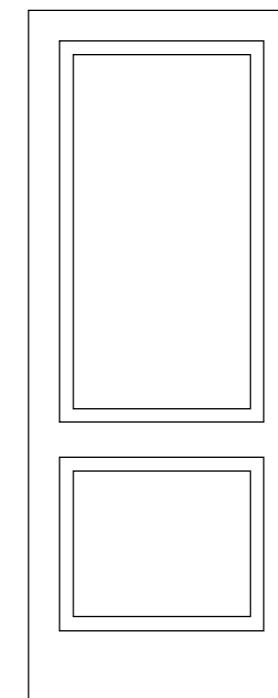

2

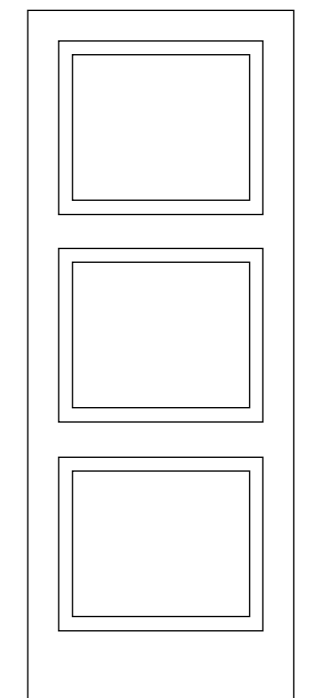

3

For/Per
V0, V1, V2, V3, VSE Minima,
VSI, VPivot, Wood

V1 V2
Only opaque jamb, both glossy and opaque door
/Stipite solo opaco, anta sia lucida che opaca

Technicals / Schede Tecniche

Hinged Doors /Porte Battenti

W/O Frames / Senza Coprifili

V0, V0 Alu	P.266
V0 Arco	268
V0C	270
Como	272
Bellagio	274
V3	276

W/ Frames / Con Coprifili

V1	P.278
V2	280
V1C	279
V2C	281

Pivot Doors /Porte Bilico

VPivot	P.282
Como	284
Bellagio, Bella, Collage, Mosaico, Industrial, Vertical, Mondrian, Linee	275

Sliding Doors /Porte Scorrevoli

VSEMinima	P.286
VSI	288

Sliding System /Sistemi Scorrevoli

Wood	P.290
Como	292
Bellagio, Bella, Collage, Mosaico, Industrial, Vertical, Mondrian, Linee	294
Cernobbio	296

Other Products /Altri Prodotti

VWall	P.298
VCloset	299
VTheca	300



ENG



ITA

Sezione verticale Vertical section

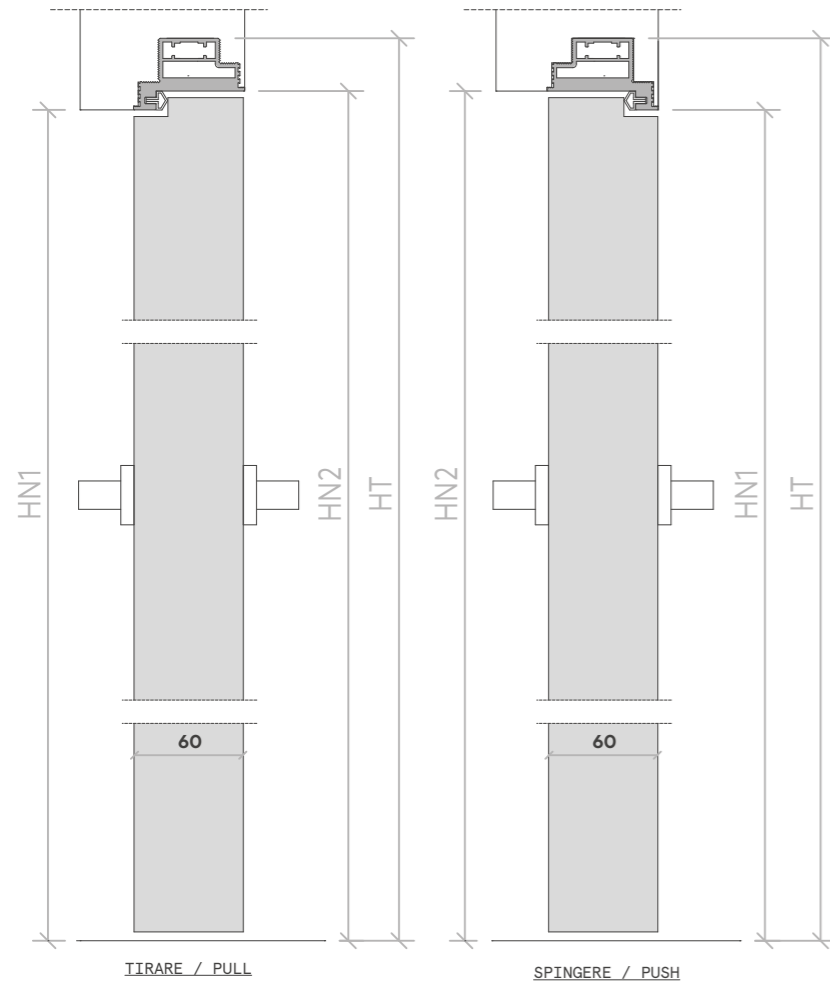

VO 2100 x 800 misure in mm
VO 2100 x 800 measures in mm

HT ALTEZZA VANO ESTERNO TELAIO 2140
ROUGH OPENING HEIGHT

HN1 ALTEZZA LUCE NETTA 1 2101
HEIGHT REAL CLEAR OPENING 1

HN2 ALTEZZA LUCE NETTA 2 2111
HEIGHT REAL CLEAR OPENING 2

LT LARGHEZZA VANO MURO Vedi dettaglio
WIDTH ROUGH OPENING See detail

LN1 LARGHEZZA LUCE NETTA 1 802
WIDTH REAL CLEAR OPENING 1

LN2 LARGHEZZA LUCE NETTA 2 822
WIDTH REAL CLEAR OPENING 2

Dettaglio telaio VO Detail VO frame

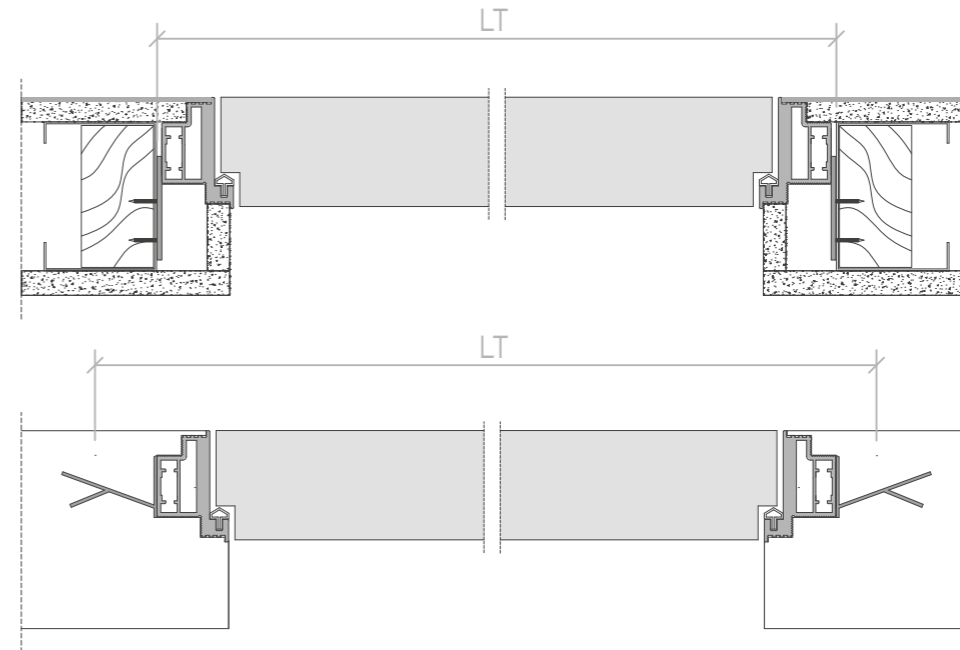

VO 2100x800 misure in mm
VO 2100x800 measures in mm

TELAIO CARTONGESSO
PLASTERBOARD FRAME

LARGHEZZA VANO MURO LT 883
WIDTH ROUGH OPENING

TOLLERANZA TOLERANCE -0 / +10

TELAIO MURATURA
BRICKWALL FRAME

LARGHEZZA VANO MURO LT 920
WIDTH ROUGH OPENING

Sezione orizzontale Horizontal section

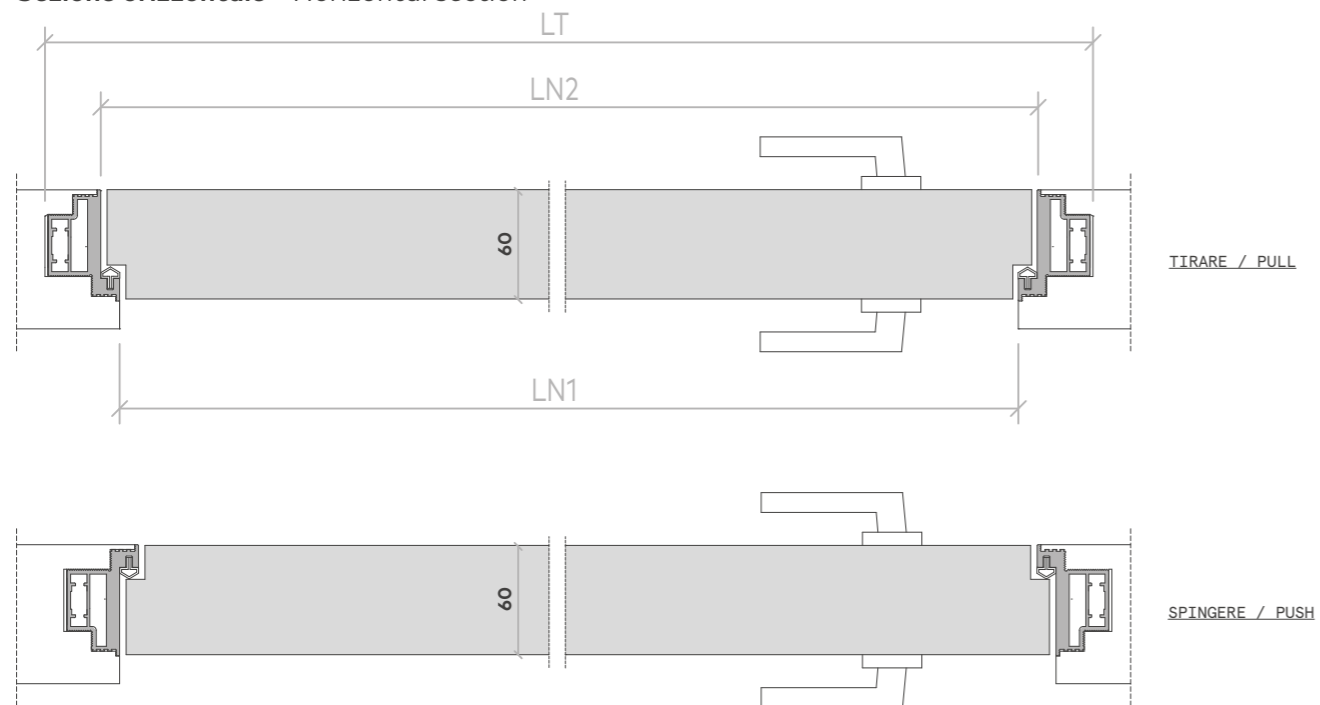

Mano d'apertura Hand opening

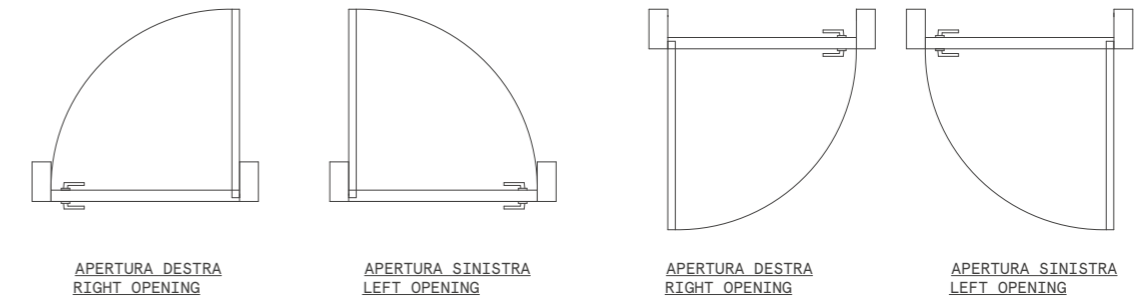

Maniglia Handle

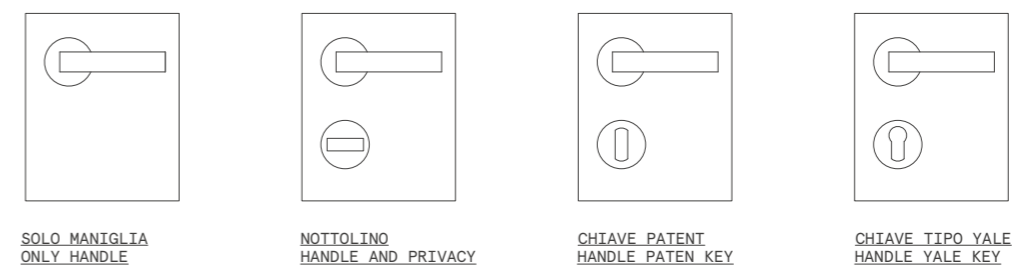

Sezione verticale Vertical section

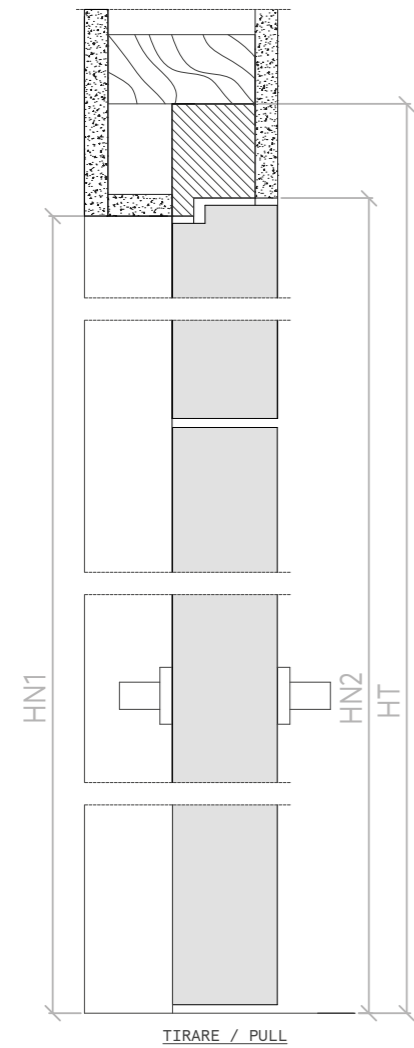

VO ARCO 2400x800 misure in mm
VO ARCH 2400 x 800 measures in mm

HT	ALTEZZA VANO ESTERNO DIMA ROUGH OPENING HEIGHT	2500
HN1	ALTEZZA LUCE NETTA HEIGHT REAL CLEAR OPENING	2401
HN2	ALTEZZA LUCE NETTA HEIGHT REAL CLEAR OPENING	2411
LT	LARGHEZZA VANO MURO WIDTH ROUGH OPENING	Vedi dettaglio See detail
LN1	LARGHEZZA LUCE NETTA 1 WIDTH REAL CLEAR OPENING 1	802
LN2	LARGHEZZA LUCE NETTA 2 WIDTH REAL CLEAR OPENING 2	822

DISPONIBILE SOLO VERSIONE A TIRARE
AVAILABLE ONLY FLUSH FROM PULLING SIDE

Mano d'apertura Hand opening

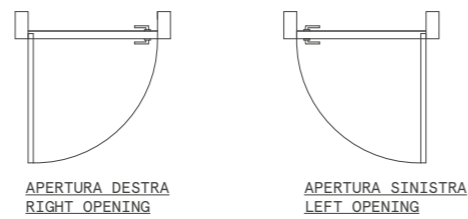

Dettaglio telaio VO ARCO Detail VO ARCH frame

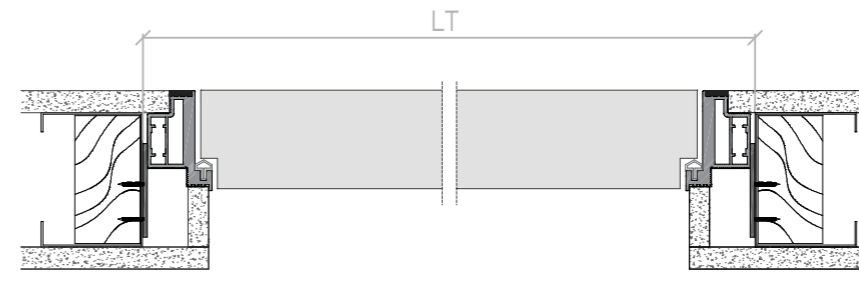

TELAIO CARTONGESSO PLATERBOARD FRAME		
LT	LARGHEZZA VANO MURO WIDTH REAL CLEAR OPENING 1	883
LN2	TOLLERANZA TOLERANCE	-0 / +10

VO ARCO 2400 x 800 misure in mm
VO ARCH 2400 x 800 measures in mm

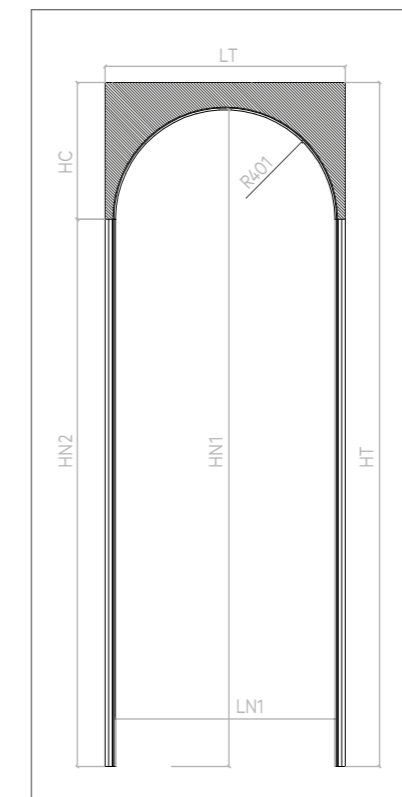

Sezione verticale Vertical section

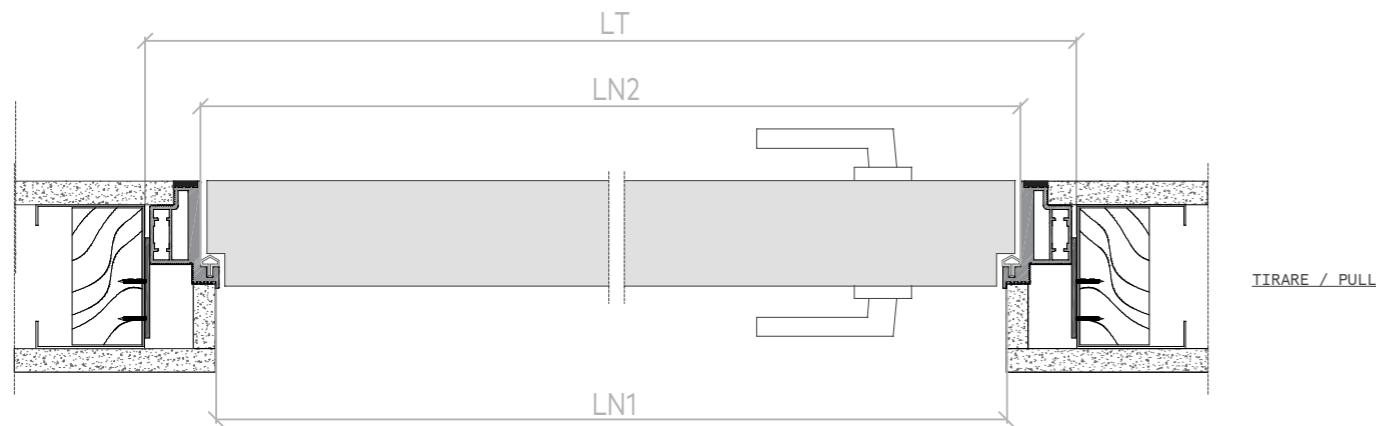

Maniglia Handle

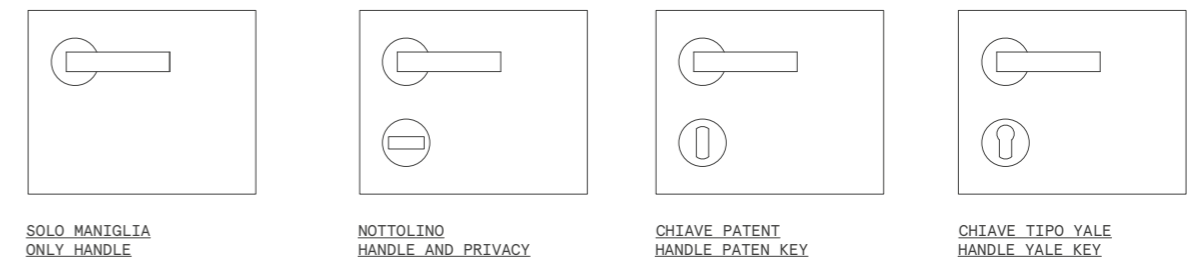

Sezione verticale Vertical section

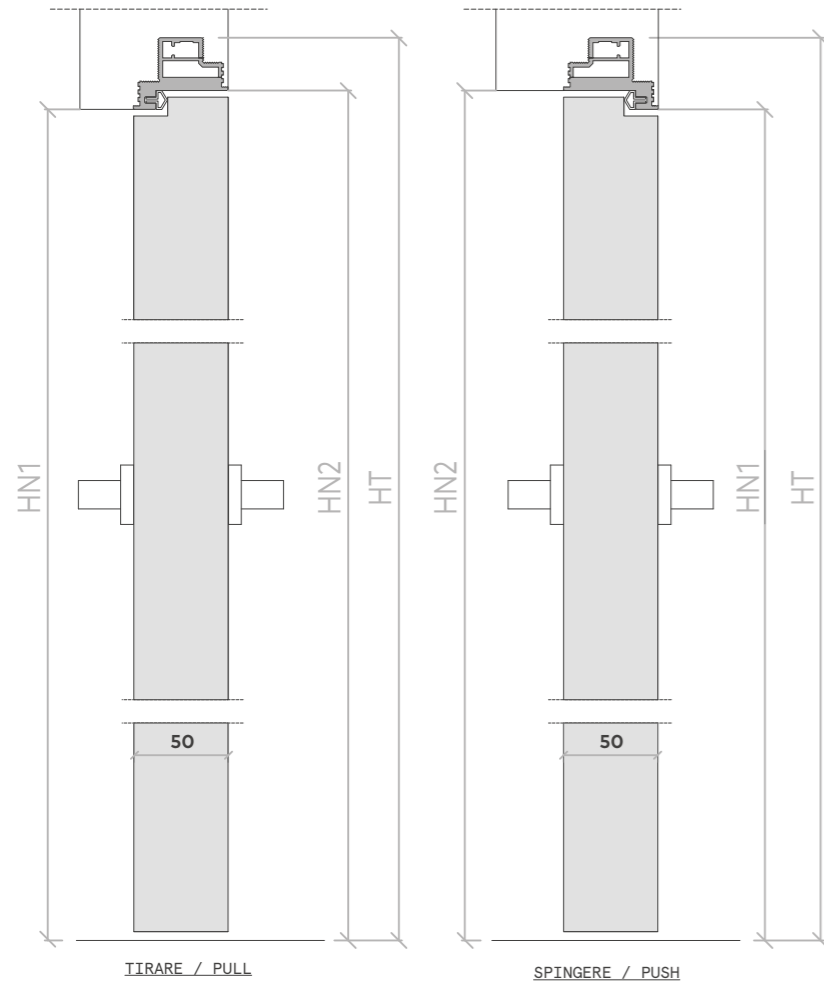

VOC 2100x800 misure in mm
VOC 2100 x 800 measures in mm

HT ALTEZZA VANO ESTERNO TELAIO 2140
ROUGH OPENING HEIGHT

HN1 ALTEZZA LUCE NETTA 1 2101
HEIGHT REAL CLEAR OPENING 1

HN2 ALTEZZA LUCE NETTA 2 2111
HEIGHT REAL CLEAR OPENING 2

LT LARGHEZZA VANO MURO Vedi dettaglio
WIDTH ROUGH OPENING See detail

LN1 LARGHEZZA LUCE NETTA 1 802
WIDTH REAL CLEAR OPENING 1

LN2 LARGHEZZA LUCE NETTA 2 822
WIDTH REAL CLEAR OPENING 2

Sezione orizzontale Horizontal section

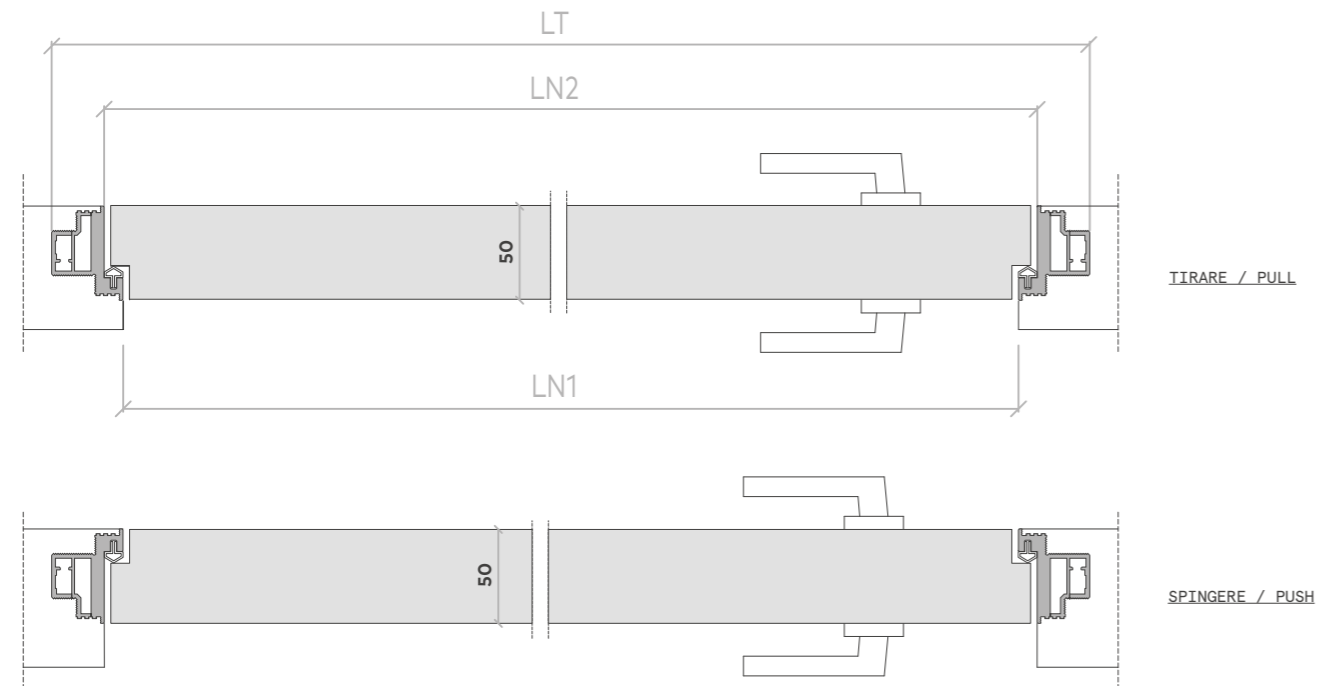

Dettaglio telaio VOC Detail VOC frame

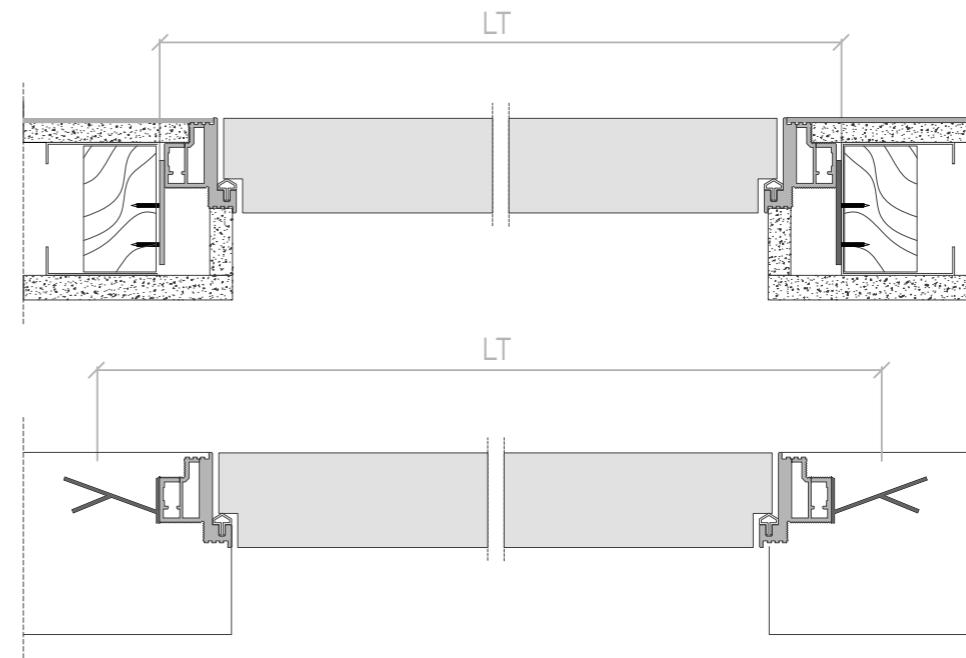

VOC 2100x800 misure in mm
VOC 2100x800 measures in mm

TELAIO CARTONGESSO
PLASTERBOARD FRAME

LARGHEZZA VANO MURO LT 883
WIDTH ROUGH OPENING

TOLLERANZA TOLERANCE -0 / +10

TELAIO MURATURA
BRICKWALL FRAME

LARGHEZZA VANO MURO LT 920
WIDTH ROUGH OPENING

Mano d'apertura Hand opening

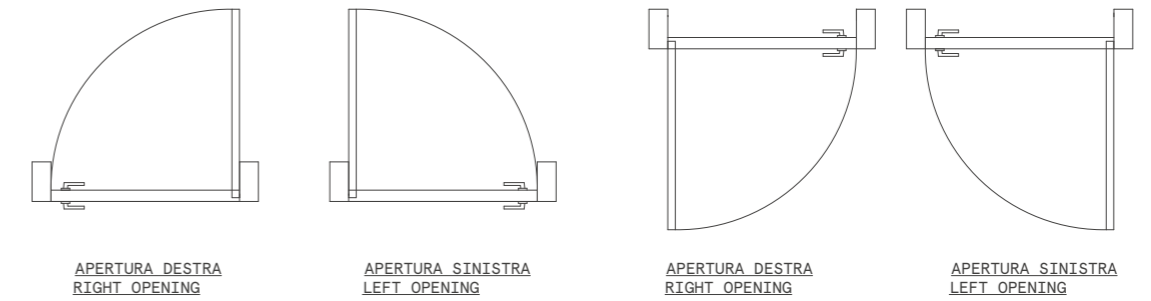

Maniglia Handle

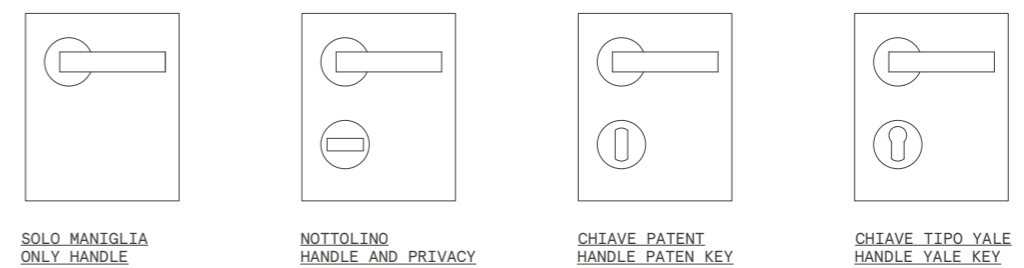

Como Battente



ENG



ITA

Sezione verticale Vertical section

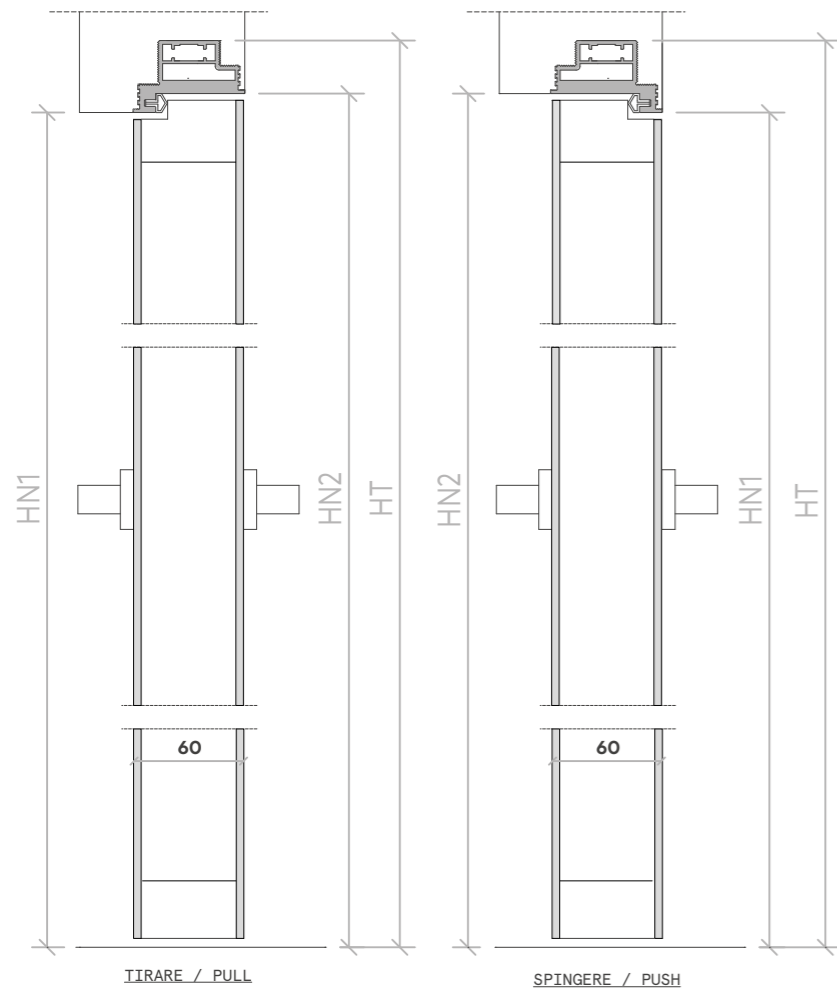

COMO 2100 x 800 misure in mm
COMO 2100 x 800 measures in mm

HT	ALTEZZA VANO ESTERNO TELAIO HEIGHT ROUGH OPENING	2140
HN1	ALTEZZA LUCE NETTA 1 HEIGHT REAL CLEAR OPENING 1	2101
HN2	ALTEZZA LUCE NETTA 2 HEIGHT REAL CLEAR OPENING 2	2111
LT	LARGHEZZA VANO MURO WIDTH ROUGH OPENING	Vedi dettaglio See detail
LN1	LARGHEZZA LUCE NETTA 1 WIDTH REAL CLEAR OPENING 1	802
LN2	LARGHEZZA LUCE NETTA 2 WIDTH REAL CLEAR OPENING 2	822

Sezione orizzontale Horizontal section

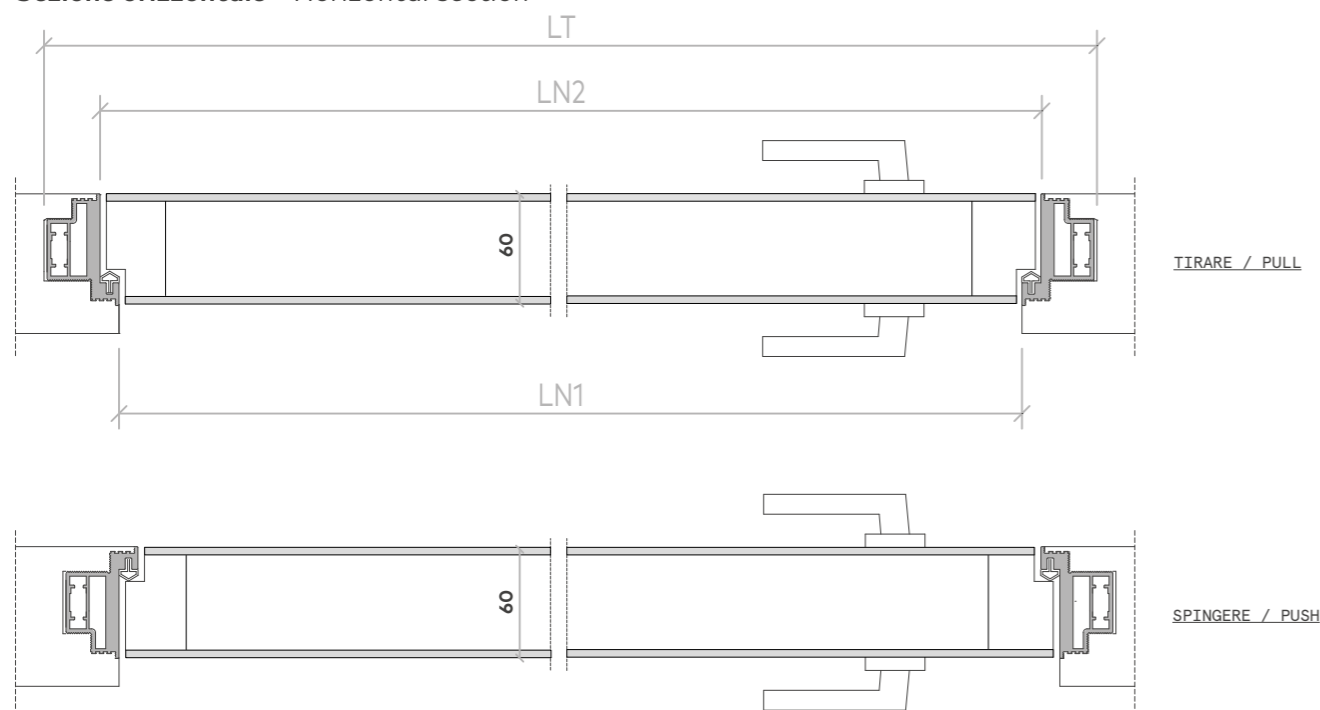

Dettaglio telaio COMO Detail COMO frame

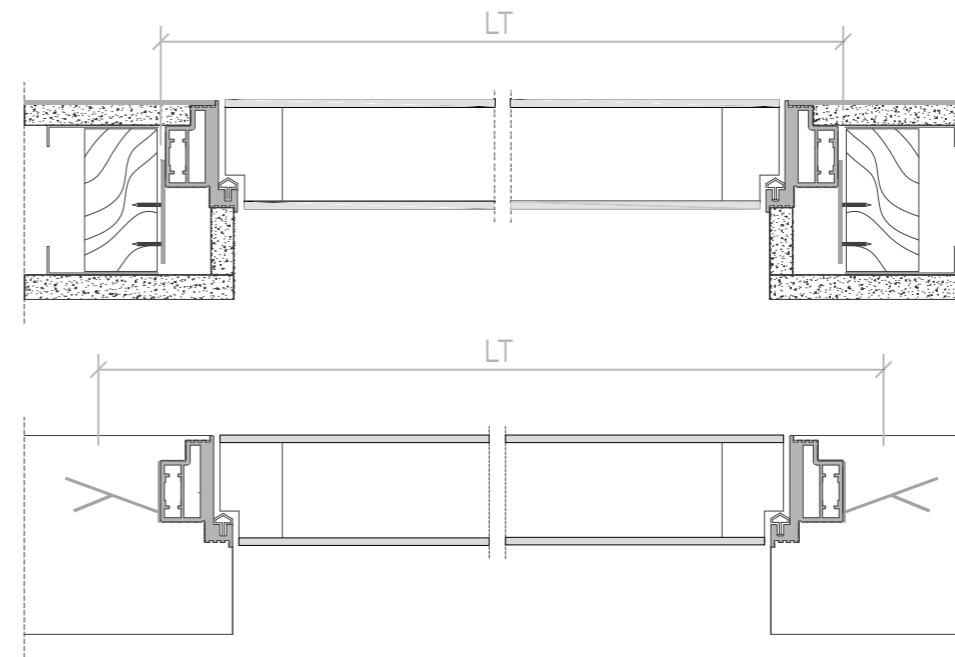

COMO 2100x800 misure in mm
COMO 2100x800 measures in mm

TELAIO CARTONGESSO PLATERBOARD FRAME	
LARGHEZZA VANO MURO WIDTH ROUGH OPENING	LT 883
TOLLERANZA TOLERANCE	-0 / +10

TELAIO MURATURA BRICKWALL FRAME	
LARGHEZZA VANO MURO WIDTH ROUGH OPENING	LT 920

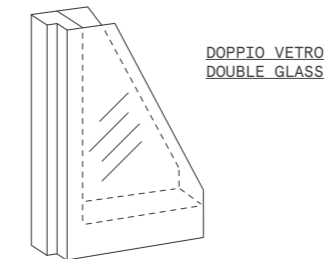
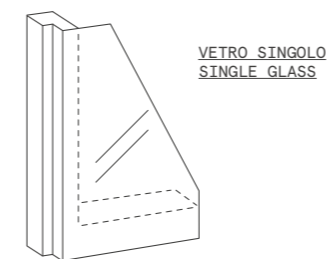

Mano d'apertura Hand opening



APERTURA DESTRA
RIGHT OPENING



APERTURA SINISTRA
LEFT OPENING

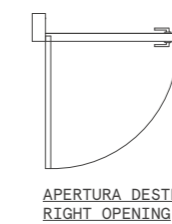

APERTURA DESTRA
RIGHT OPENING

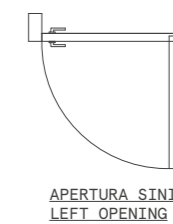

APERTURA SINISTRA
LEFT OPENING

Maniglia Handle

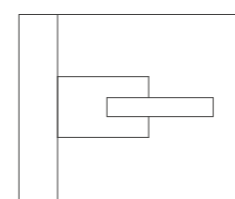

SOLO MANIGLIA
ONLY HANDLE

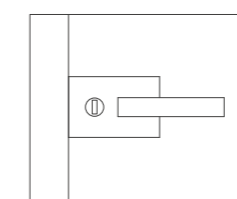

NOTTOLINO
HANDLE AND PRIVACY

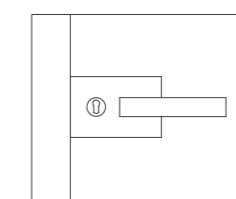

CHIAVE TIPO YALE
HANDLE YALE KEY

Bellagio Battente, Bella, Collage, Mosaico, Industrial, Vertical, Mondrian, Linee

Sezione verticale Vertical section

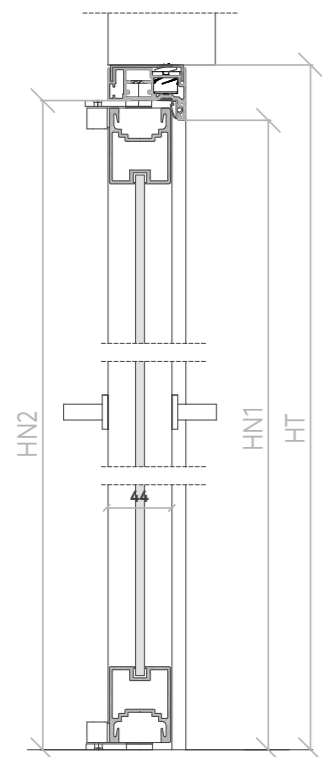

BELLAGIO 2100 x 800 misure in mm
BELLAGIO 2100x800 measures in mm

HT	ALTEZZA VANO ESTERNO TELAIO HEIGHT ROUGH OPENING	2140
HN1	ALTEZZA LUCE NETTA 1 HEIGHT REAL CLEAR OPENING 1	2101
HN2	ALTEZZA LUCE NETTA 2 HEIGHT REAL CLEAR OPENING 2	2115
LT	LARGHEZZA VANO MURO WIDTH ROUGH OPENING	880
LN1	LARGHEZZA LUCE NETTA 1 WIDTH REAL CLEAR OPENING 1	802
LN2	LARGHEZZA LUCE NETTA 2 WIDTH REAL CLEAR OPENING 2	830

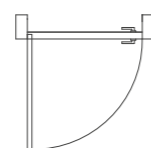

APERTURA DESTRA
RIGHT OPENING

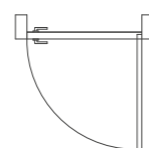

APERTURA SINISTRA
LEFT OPENING

Sezione orizzontale Horizontal section

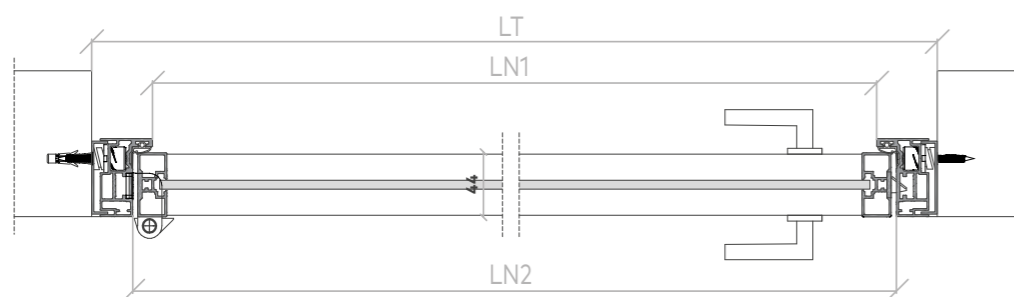

Maniglia Handle

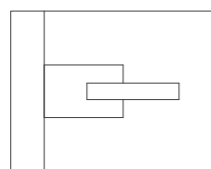

SOLO MANIGLIA
ONLY HANDLE

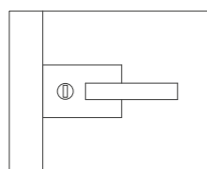

NOTTOLINO
HANDLE AND PRIVACY

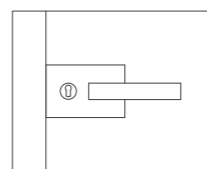

CHIAVE TIPO YALE
HANDLE YALE KEY

Bellagio Pivot, Bella, Collage, Mosaico, Industrial, Vertical, Mondrian, Linee

Sezione verticale Vertical section



Sezione orizzontale Horizontal section



MECCANISMO LATERALE
/LATERAL MECHANISM

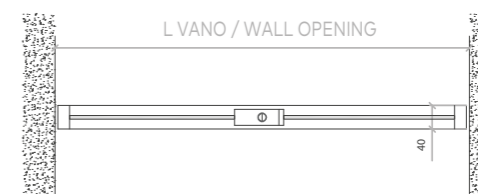

MECCANISMO CENTRALE
/CENTRAL MECHANISM

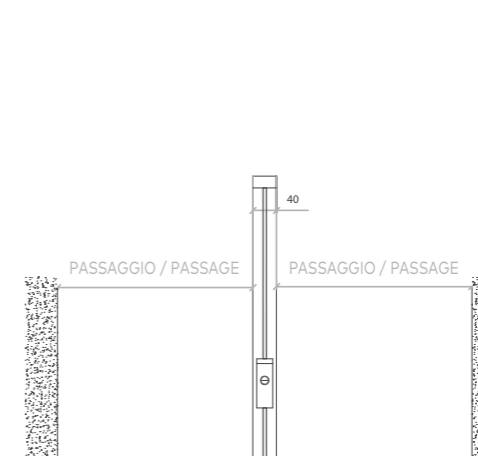
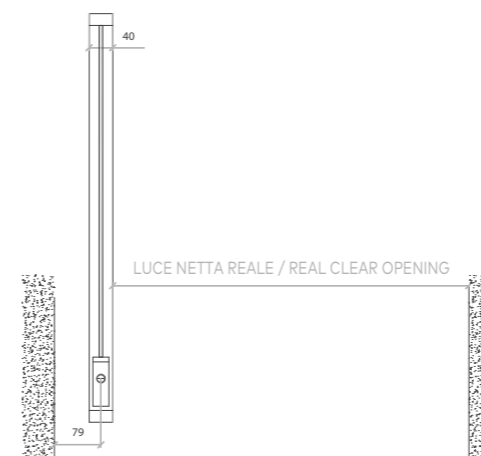



ENG



ITA

Sezione verticale Vertical section

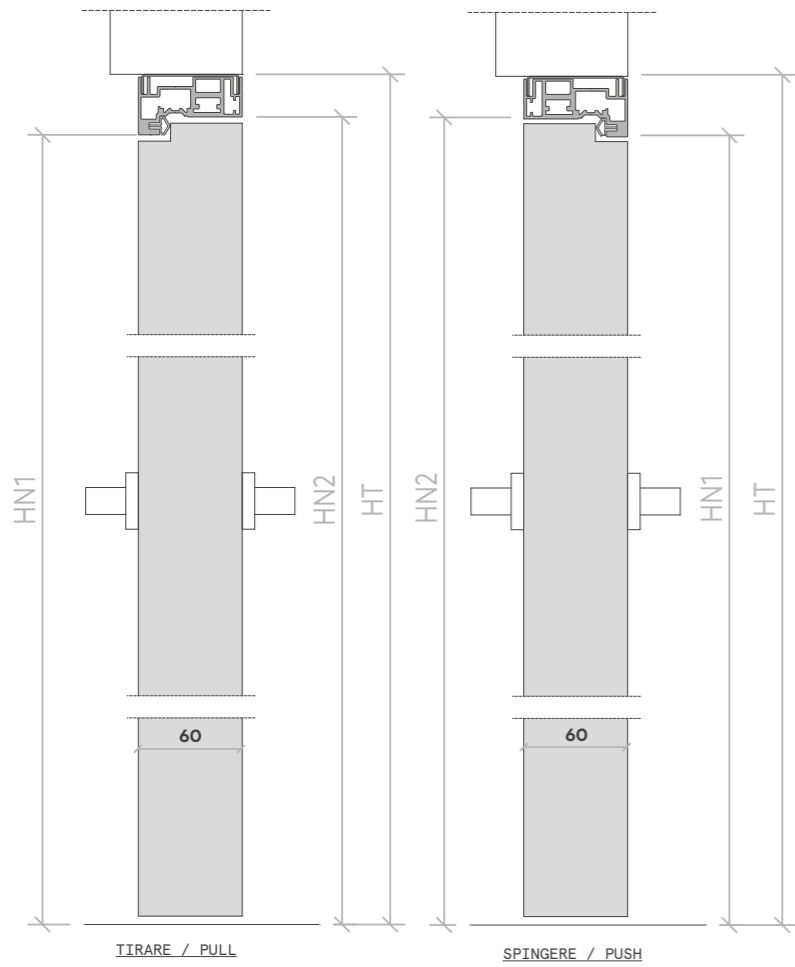

V3 2100 × 800 misure in mm
V3 2100 × 800 measures in mm

HT	ALTEZZA VANO ESTERNO TELAIO HEIGHT ROUGH OPENING	2137
HN1	ALTEZZA LUCE NETTA 1 HEIGHT REAL CLEAR OPENING 1	2101
HN2	ALTEZZA LUCE NETTA 2 HEIGHT REAL CLEAR OPENING 2	2111
LT	LARGHEZZA VANO MURO WIDTH ROUGH OPENING	873
LN1	LARGHEZZA LUCE NETTA 1 WIDTH REAL CLEAR OPENING 1	802
LN2	LARGHEZZA LUCE NETTA 2 WIDTH REAL CLEAR OPENING 2	822

Sezione orizzontale Horizontal section

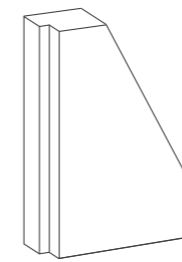
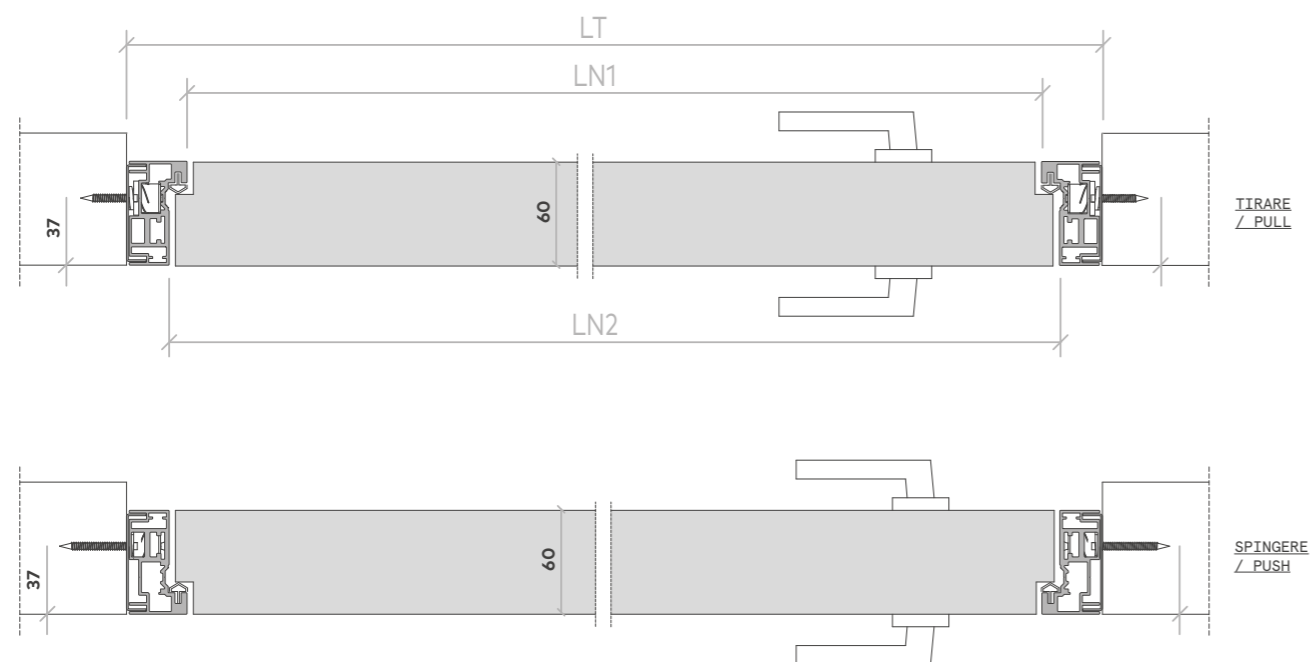

ANTAL LEGNO
WOODEN PANEL

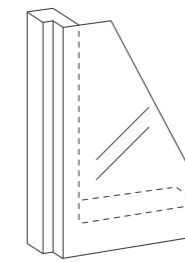

VETRO SINGOLO
SINGLE GLASS

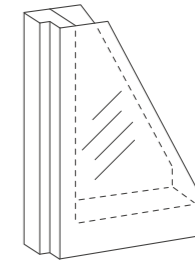

DOPPIO VETRO
DOUBLE GLASS

Mano d'apertura Hand opening

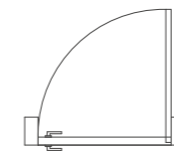

APERTURA DESTRA
RIGHT OPENING

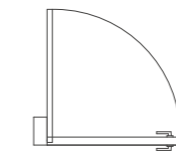

APERTURA SINISTRA
LEFT OPENING

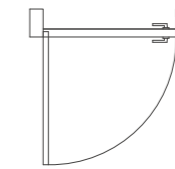

APERTURA DESTRA
RIGHT OPENING

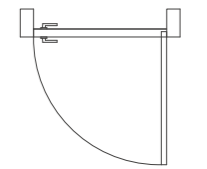

APERTURA SINISTRA
LEFT OPENING

Maniglia (legno) Handle (wood)

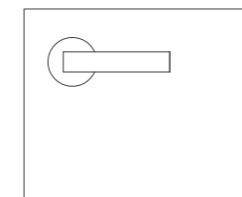

SOLO MANIGLIA
ONLY HANDLE

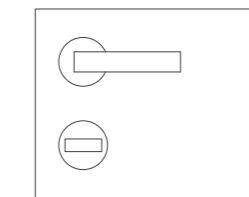

NOTTOLINO
HANDLE AND PRIVACY

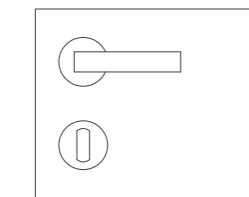

CHIAVE PATENT
HANDLE PATEN KEY

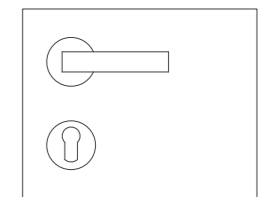

CHIAVE TIPO YALE
HANDLE YALE KEY

Maniglia (vetro) Handle (glass)

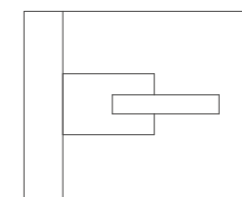

SOLO MANIGLIA
ONLY HANDLE

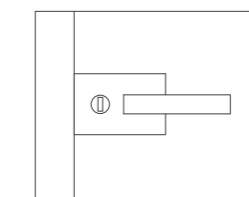

NOTTOLINO
HANDLE AND PRIVACY

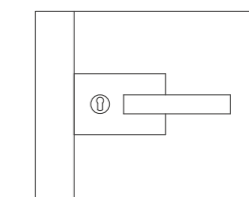

CHIAVE TIPO YALE
HANDLE YALE KEY



ENG



ITA

Sezione verticale Vertical section

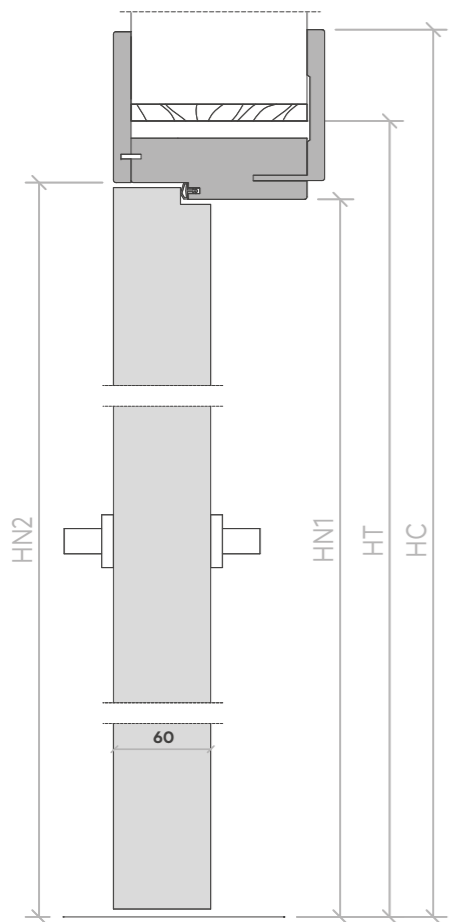

V1 2100 x 800 misure in mm
V1 2100 x 800 measures in mm

HT	ALTEZZA INTERNO FALSO TELAIO HOLE IN THE WALL HEIGHT	2150
HN1	ALTEZZA LUCE NETTA 1 HEIGHT REAL CLEAR OPENING 1	2101
HN2	ALTEZZA LUCE NETTA 2 HEIGHT REAL CLEAR OPENING 2	2111
HC	ALTEZZA ESTERNO COPRIFILO HEIGHT EXTERNAL TRIM	2200
LT	LARGHEZZA INTERNO FALSO TELAIO WIDTH ROUGH OPENING	900
LN1	LARGHEZZA LUCE NETTA 1 WIDTH REAL CLEAR OPENING 1	802
LN2	LARGHEZZA LUCE NETTA 2 WIDTH REAL CLEAR OPENING 2	822
LC	LARGHEZZA ESTERNO COPRIFILO WIDTH EXTERNAL TRIM	1005
Sp	SPESSORE STIPITE JAMB THICKNESS	105

Maniglia Handle

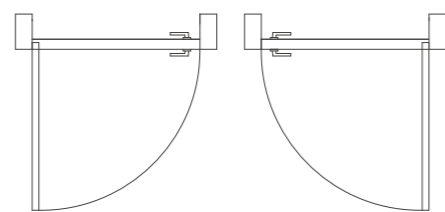

APERTURA DESTRA
RIGHT OPENING

APERTURA SINISTRA
LEFT OPENING

Sezione orizzontale Horizontal section

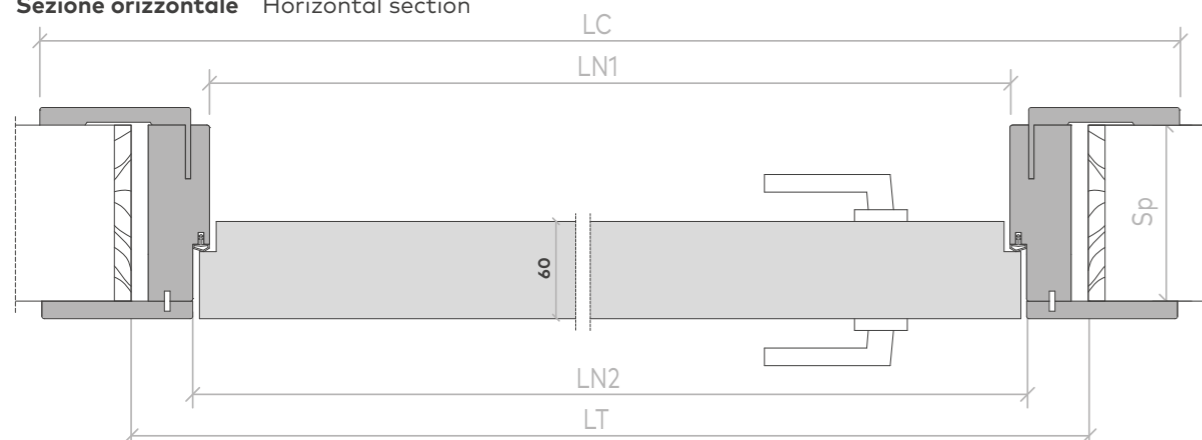

Maniglia
Handle

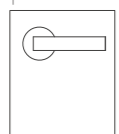

SOLO MANIGLIA
ONLY HANDLE

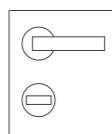

NOTTOLINO
HANDLE AND PRIVACY

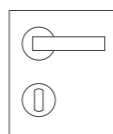

CHIAVE PATENT
HANDLE PATEN KEY

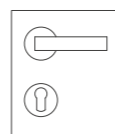

CHIAVE TIPO YALE
HANDLE YALE KEY

Sezione verticale Vertical section

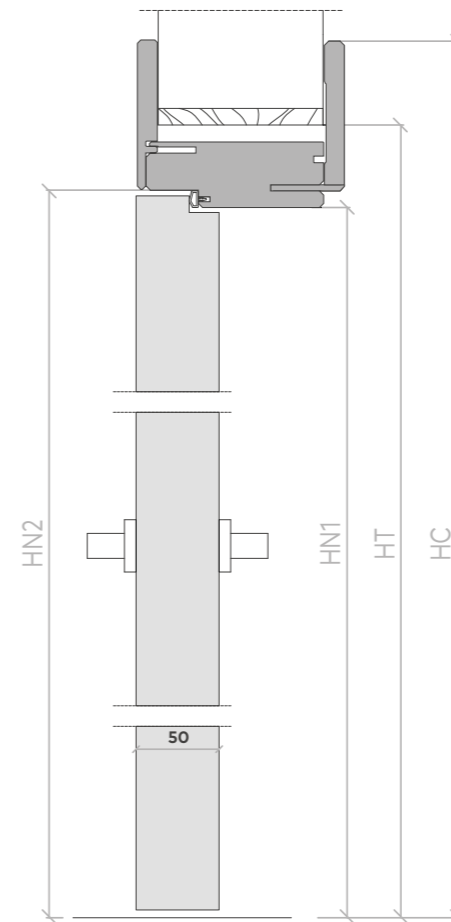

V1C 2100 x 800 misure in mm
V1C 2100 x 800 measures in mm

HT	ALTEZZA INTERNO FALSO TELAIO HOLE IN THE WALL HEIGHT	2150
HN1	ALTEZZA LUCE NETTA 1 HEIGHT REAL CLEAR OPENING 1	2101
HN2	ALTEZZA LUCE NETTA 2 HEIGHT REAL CLEAR OPENING 2	2111
HC	ALTEZZA ESTERNO COPRIFILO HEIGHT EXTERNAL TRIM	2200
LT	LARGHEZZA INTERNO FALSO TELAIO WIDTH ROUGH OPENING	900
LN1	LARGHEZZA LUCE NETTA 1 WIDTH REAL CLEAR OPENING 1	802
LN2	LARGHEZZA LUCE NETTA 2 WIDTH REAL CLEAR OPENING 2	822
LC	LARGHEZZA ESTERNO COPRIFILO WIDTH EXTERNAL TRIM	1005
Sp	SPESSORE STIPITE JAMB THICKNESS	105

Maniglia Handle

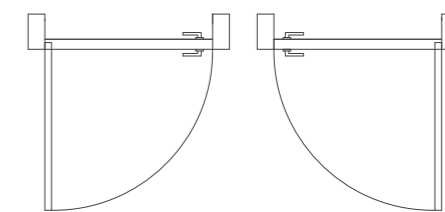

APERTURA DESTRA
RIGHT OPENING

APERTURA SINISTRA
LEFT OPENING

Sezione orizzontale Horizontal section

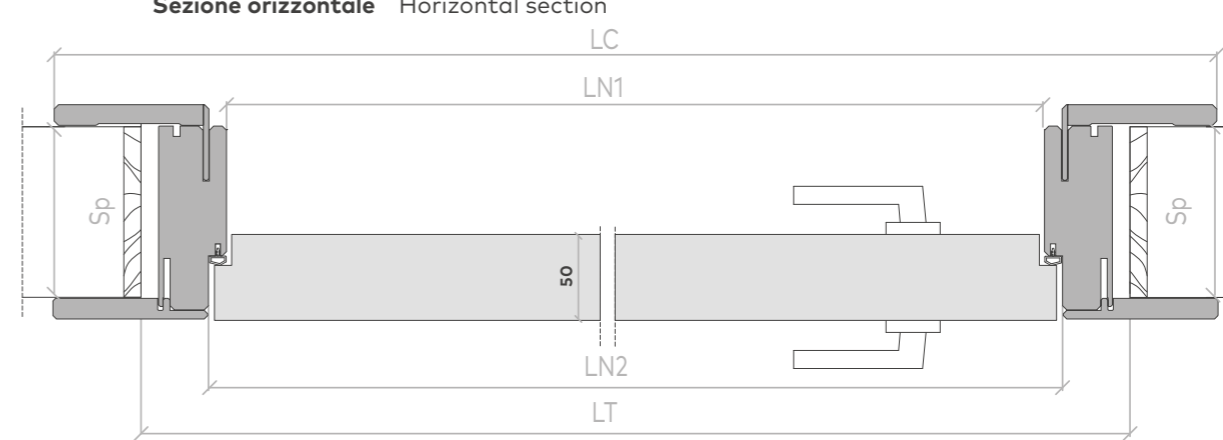

Maniglia
Handle

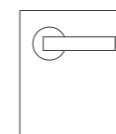

SOLO MANIGLIA
ONLY HANDLE

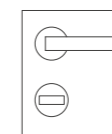

NOTTOLINO
HANDLE AND PRIVACY

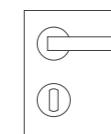

CHIAVE PATENT
HANDLE PATEN KEY

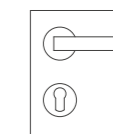

CHIAVE TIPO YALE
HANDLE YALE KEY



ENG

ITA

Sezione verticale Vertical section

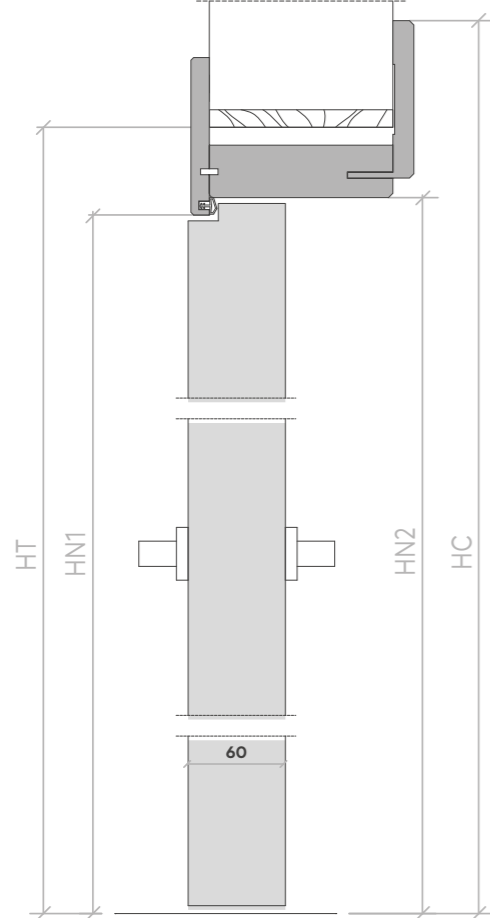

V2 2100 x 800 misure in mm
V2 2100 x 800 measures in mm

HT	ALTEZZA INTERNO FALSO TELAIO HOLE IN THE WALL HEIGHT	2150
HN1	ALTEZZA LUCE NETTA 1 HEIGHT REAL CLEAR OPENING 1	2101
HN2	ALTEZZA LUCE NETTA 2 HEIGHT REAL CLEAR OPENING 2	2111
HC	ALTEZZA ESTERNO COPRIFILO HEIGHT EXTERNAL TRIM	2210
LT	LARGHEZZA INTERNO FALSO TELAIO WIDTH ROUGH OPENING	900
LN1	LARGHEZZA LUCE NETTA 1 WIDTH REAL CLEAR OPENING 1	802
LN2	LARGHEZZA LUCE NETTA 2 WIDTH REAL CLEAR OPENING 2	822
LC	LARGHEZZA ESTERNO COPRIFILO WIDTH EXTERNAL TRIM	1025
Sp	SPESSORE STIPITE JAMB THICKNESS	105

Maniglia Handle

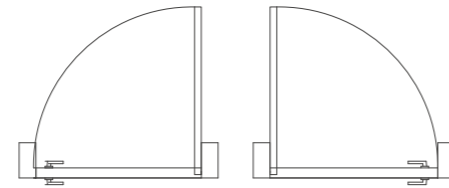

APERTURA DESTRA
RIGHT OPENING

APERTURA SINISTRA
LEFT OPENING

Sezione orizzontale Horizontal section

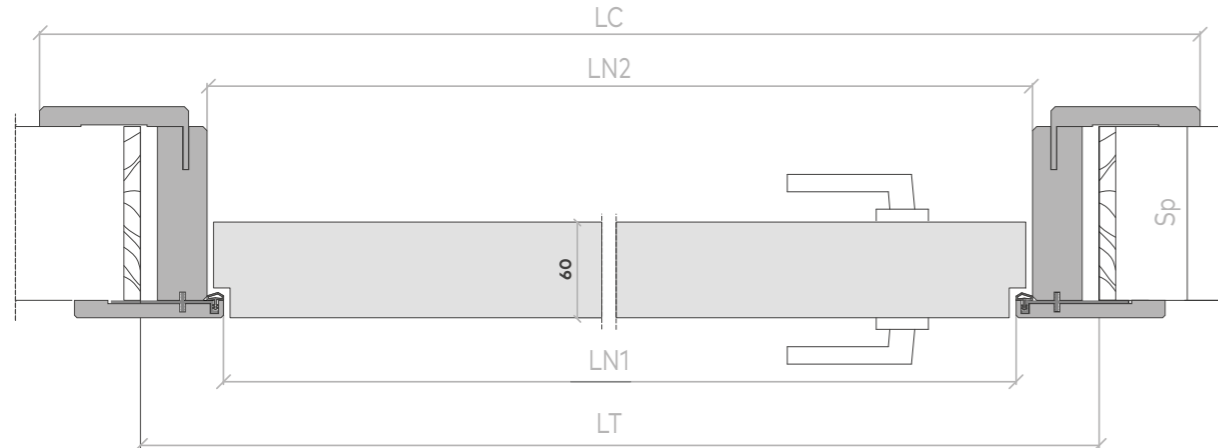

Maniglia
Handle

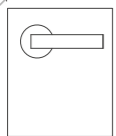

SOLO MANIGLIA
ONLY HANDLE

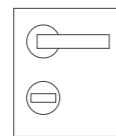

NOTTOLINO
HANDLE AND PRIVACY

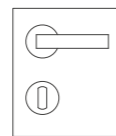

CHIAVE PATENT
HANDLE PATEN KEY

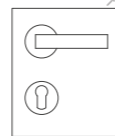

CHIAVE TIPO YALE
HANDLE YALE KEY

Sezione verticale Vertical section

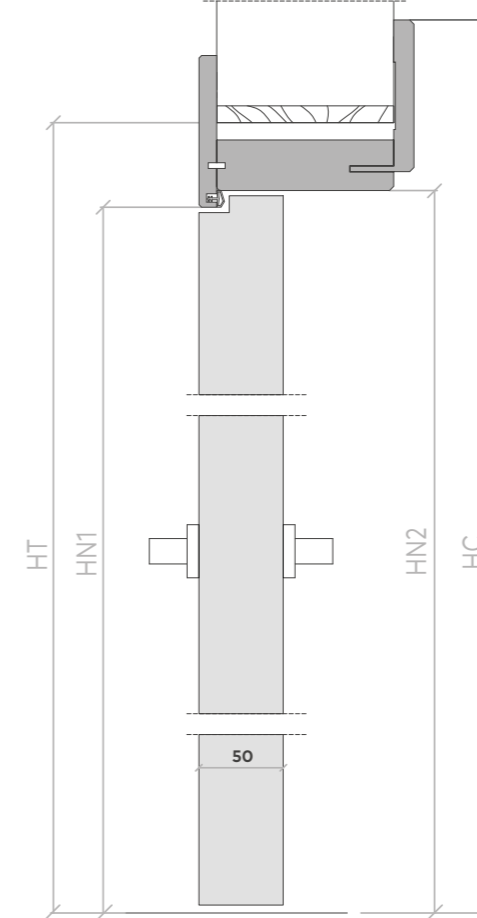

V2C 2100 x 800 misure in mm
V2C 2100 x 800 measures in mm

HT	ALTEZZA INTERNO FALSO TELAIO HOLE IN THE WALL HEIGHT	2150
HN1	ALTEZZA LUCE NETTA 1 HEIGHT REAL CLEAR OPENING 1	2101
HN2	ALTEZZA LUCE NETTA 2 HEIGHT REAL CLEAR OPENING 2	2111
HC	ALTEZZA ESTERNO COPRIFILO HEIGHT EXTERNAL TRIM	2210
LT	LARGHEZZA INTERNO FALSO TELAIO WIDTH ROUGH OPENING	900
LN1	LARGHEZZA LUCE NETTA 1 WIDTH REAL CLEAR OPENING 1	802
LN2	LARGHEZZA LUCE NETTA 2 WIDTH REAL CLEAR OPENING 2	822
LC	LARGHEZZA ESTERNO COPRIFILO WIDTH EXTERNAL TRIM	1025
Sp	SPESSORE STIPITE JAMB THICKNESS	105

Maniglia Handle

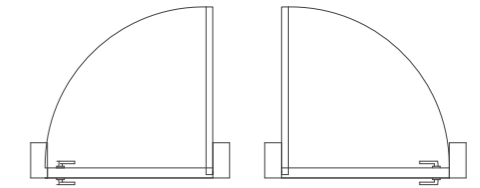

APERTURA DESTRA
RIGHT OPENING

APERTURA SINISTRA
LEFT OPENING

Sezione orizzontale Horizontal section

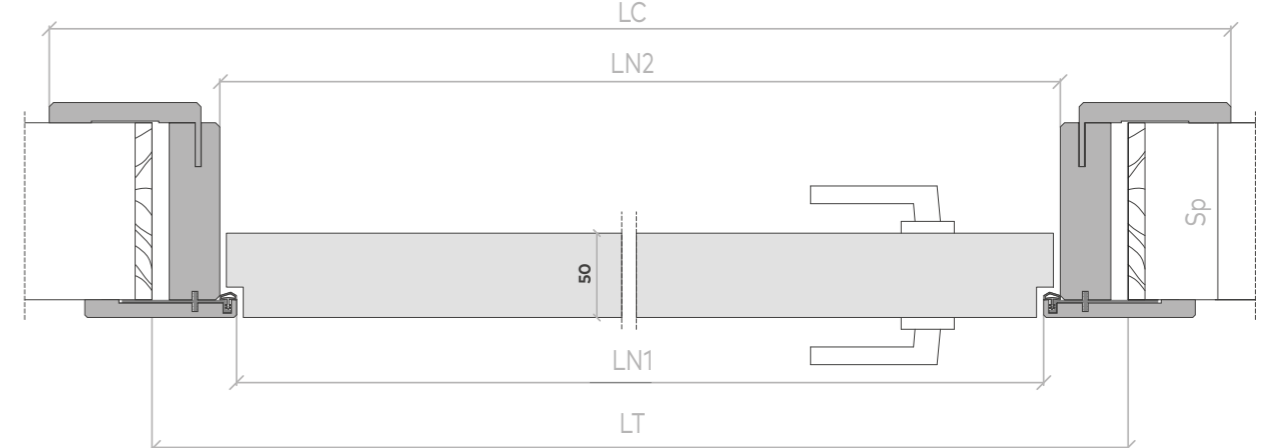

Maniglia
Handle

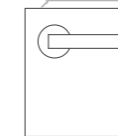

SOLO MANIGLIA
ONLY HANDLE

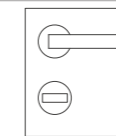

NOTTOLINO
HANDLE AND PRIVACY

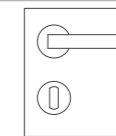

CHIAVE PATENT
HANDLE PATEN KEY

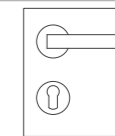

CHIAVE TIPO YALE
HANDLE YALE KEY

V Pivot



Dimensions
Height up to 5 meters,
Width up to 2 meters
/
Dimensioni
Altezza Fino a 5 metri,
Larghezza Fino a 2 metri

Panel thickness 60 mm
With aluminum frame
For brickwall
/
Anta spessore 60 mm
con telaio in alluminio
per intonaco

Panel thickness 60 mm
without aluminum frame
/
Anta spessore 60 mm
senza telaio in alluminio

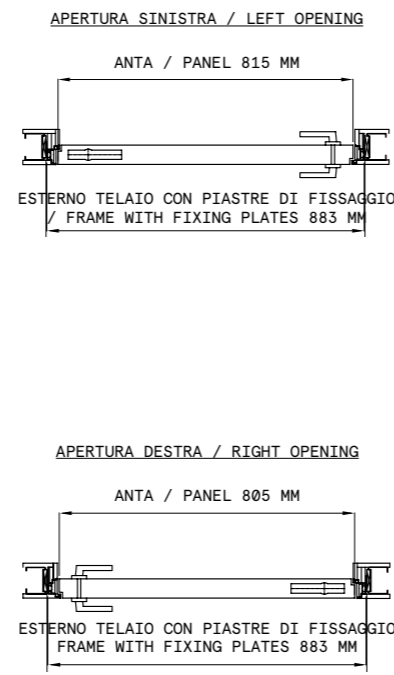
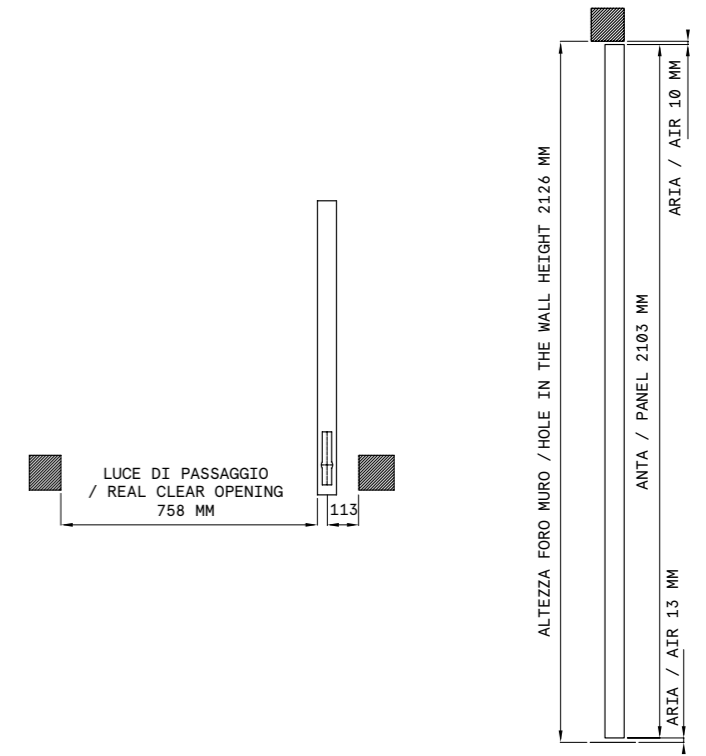
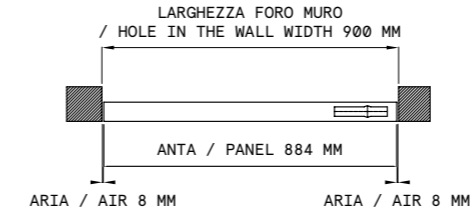
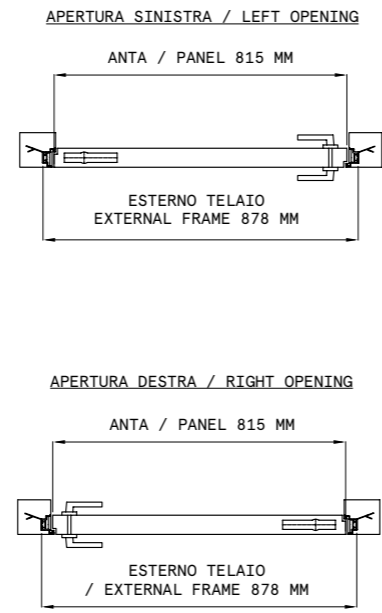
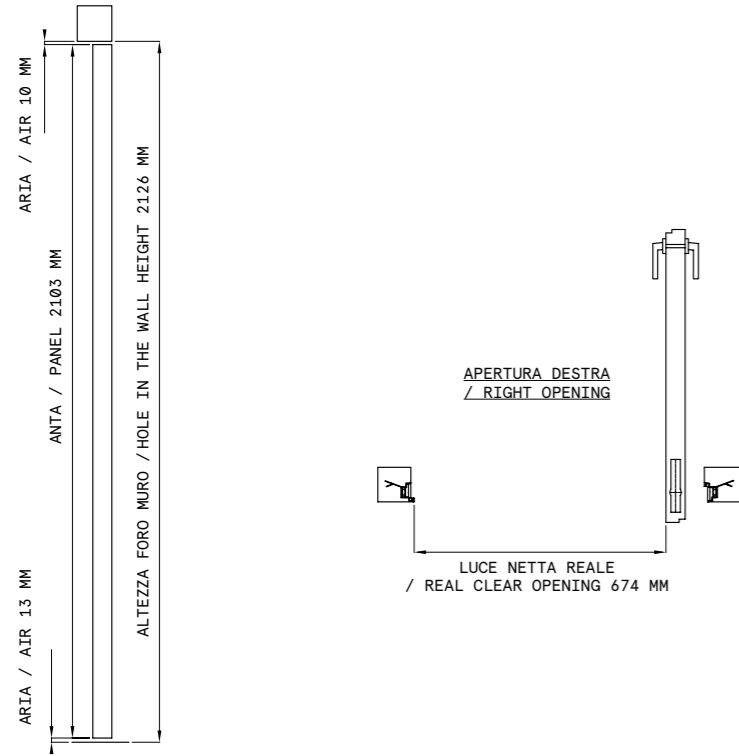

Panel thickness 100 mm
Without aluminum frame
/
Anta spessore 100 mm
senza telaio in alluminio

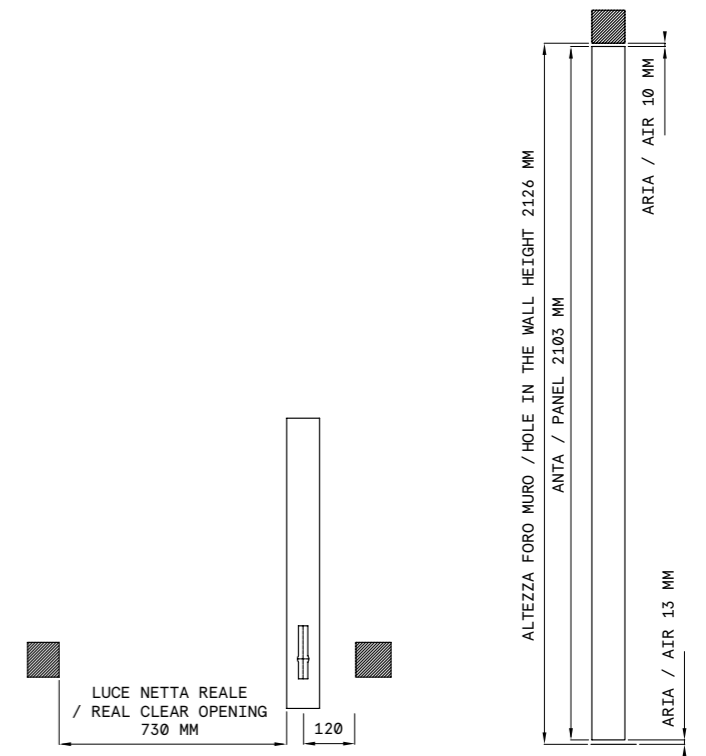
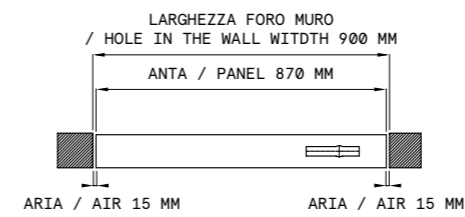

Como Pivot



ENG



ITA

Double glass / Vetro doppio

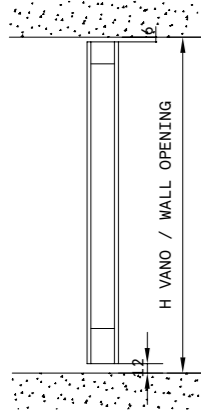

MECCANISMO LATERALE
/ LATERAL MECHANISM

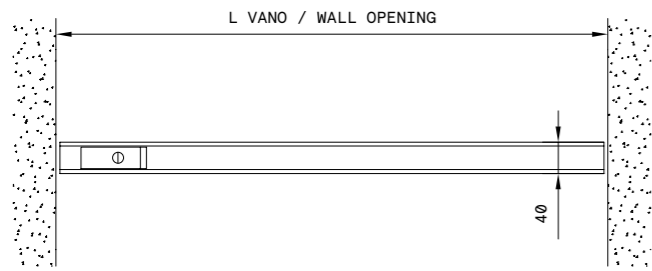

MECCANISMO CENTRALE
/ CENTRAL MECHANISM

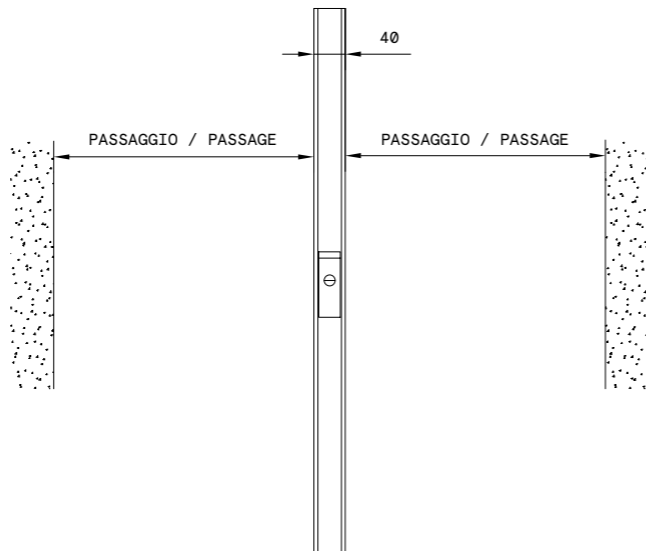
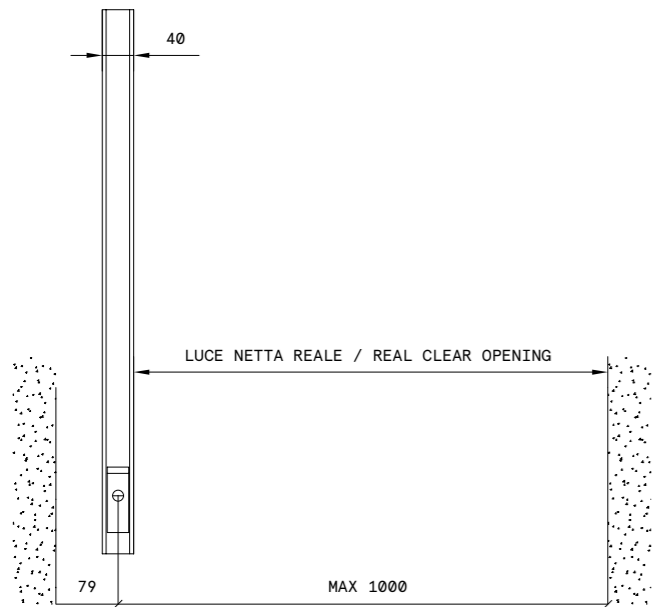
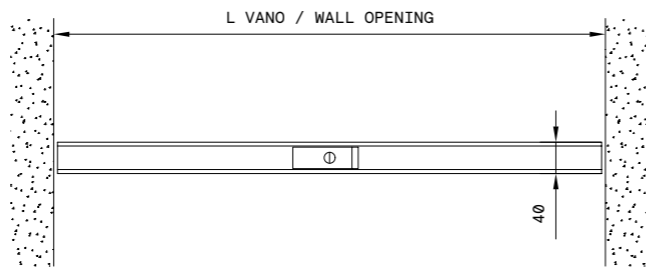

Single glass / Vetro singolo

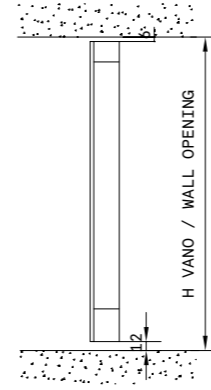

MECCANISMO LATERALE
/ LATERAL MECHANISM

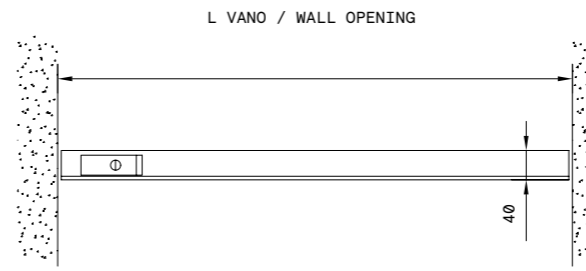

MECCANISMO CENTRALE
/ CENTRAL MECHANISM

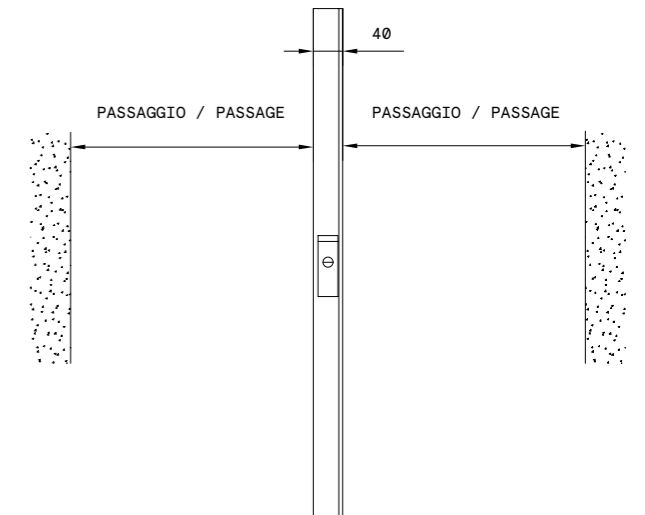
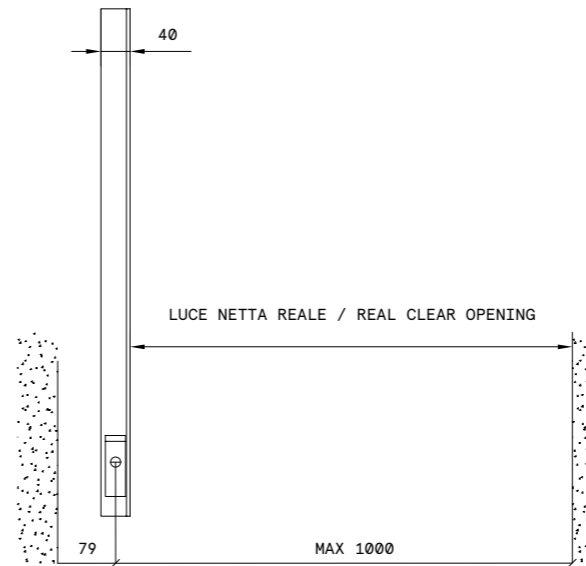
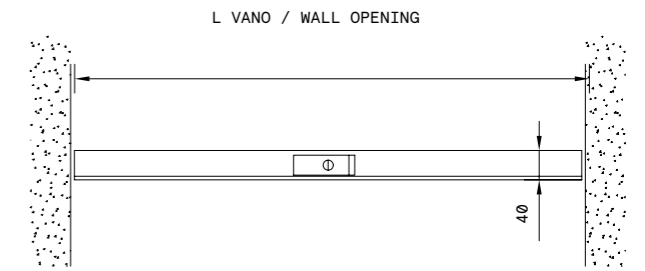

Sezione verticale Vertical section

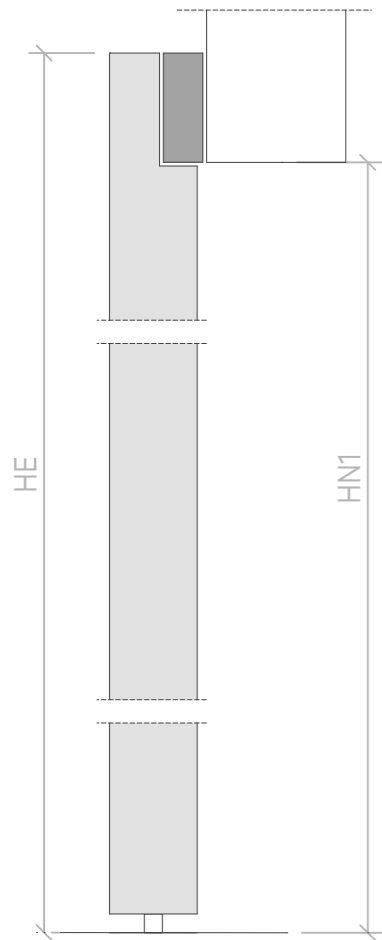

VSE MINIMA VANO 2100 × 800 misure in mm
VSE MINIMA WALL OPENING 2100 × 800 measures in mm

HE	ALTEZZA ESTERNO PANNELLO HEIGHT EXTERNAL PANEL	2180
HN1	ALTEZZA LUCE NETTA 1 HEIGHT REAL CLEAR OPENING 1	2100
LP	LARGHEZZA ANTA WIDTH PANEL	900
LN1	LARGHEZZA LUCE NETTA 1 WIDTH REAL CLEAR OPENING 1	800

Sezione orizzontale Horizontal section

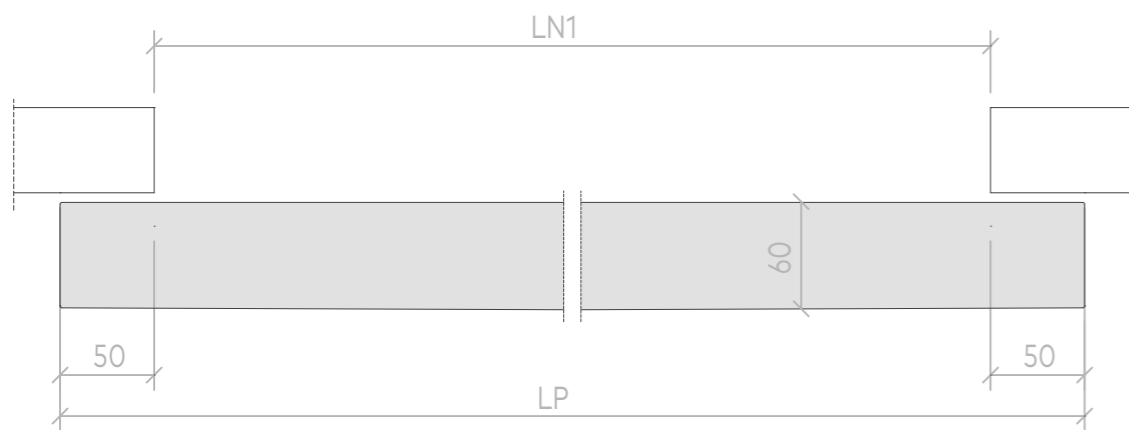

Posizione meccanismo Hardware position

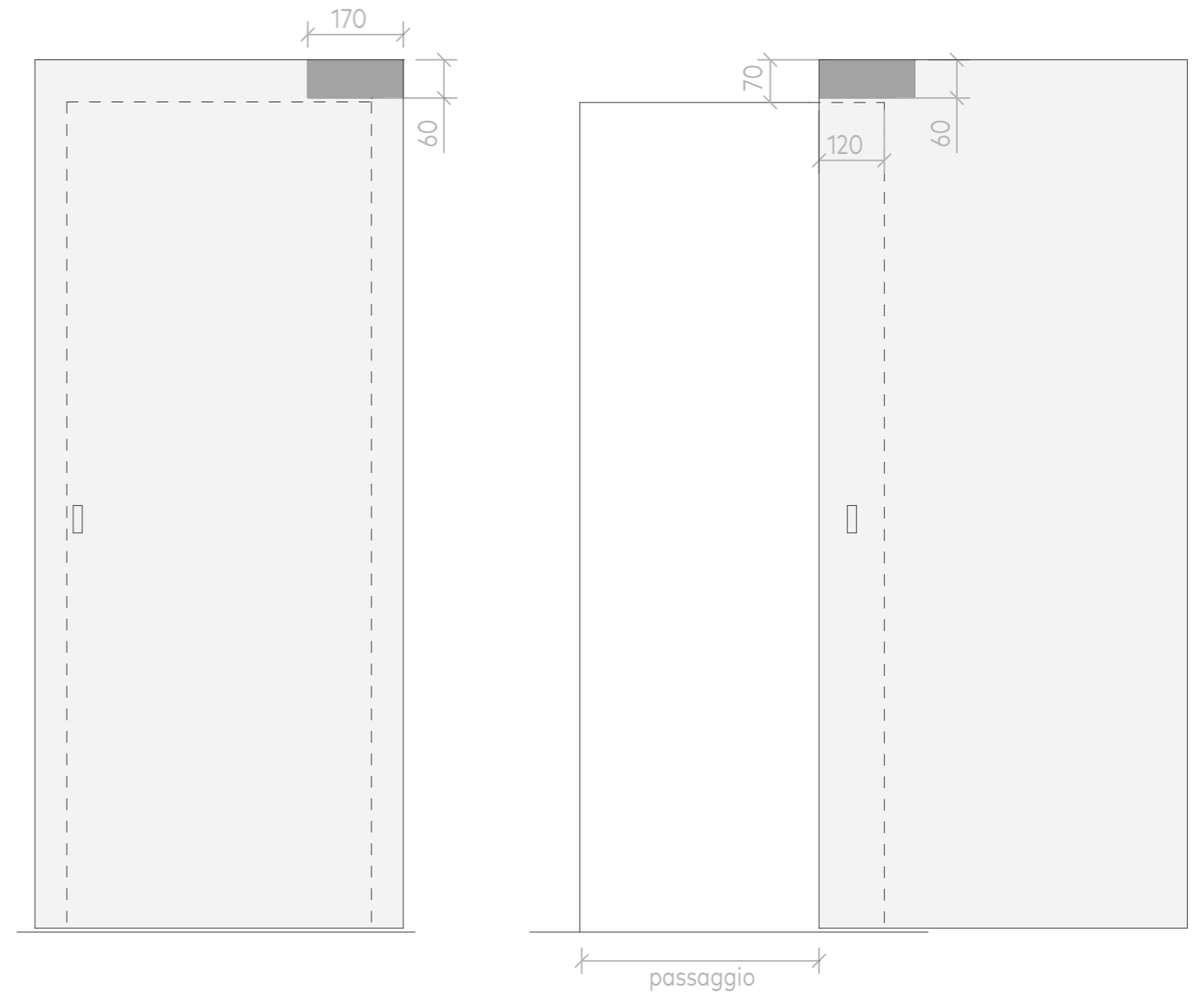

LARGHEZZA ANTA = LARGHEZZA VANO + 10 CM
 WIDTH PANEL = WIDTH CLEAR OPENING + 10 CM

ALTEZZA ANTA = ALTEZZA VANO + 7 CM
 HEIGHT PANEL = HEIGHT CLEAR OPENING + 7 CM

PASSAGGIO = VANO - 12 CM
 WITH REAL OPENING = WIDTH TO OPENING - 12 CM

Mano d'apertura Hand opening

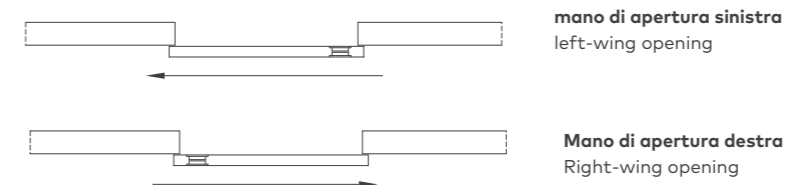

Sezione verticale Vertical section

VSI 2100 × 800 misure in mm
VSI 2100 × 800 measures in mm

HN1 ALTEZZA LUCE NETTA 1
HEIGHT REAL CLEAR OPENING 1

LN1 LARGHEZZA LUCE NETTA 1
WIDTH REAL CLEAR OPENING 1

Dimensioni variabili da marca e modello
Variable dimensions by brand and model

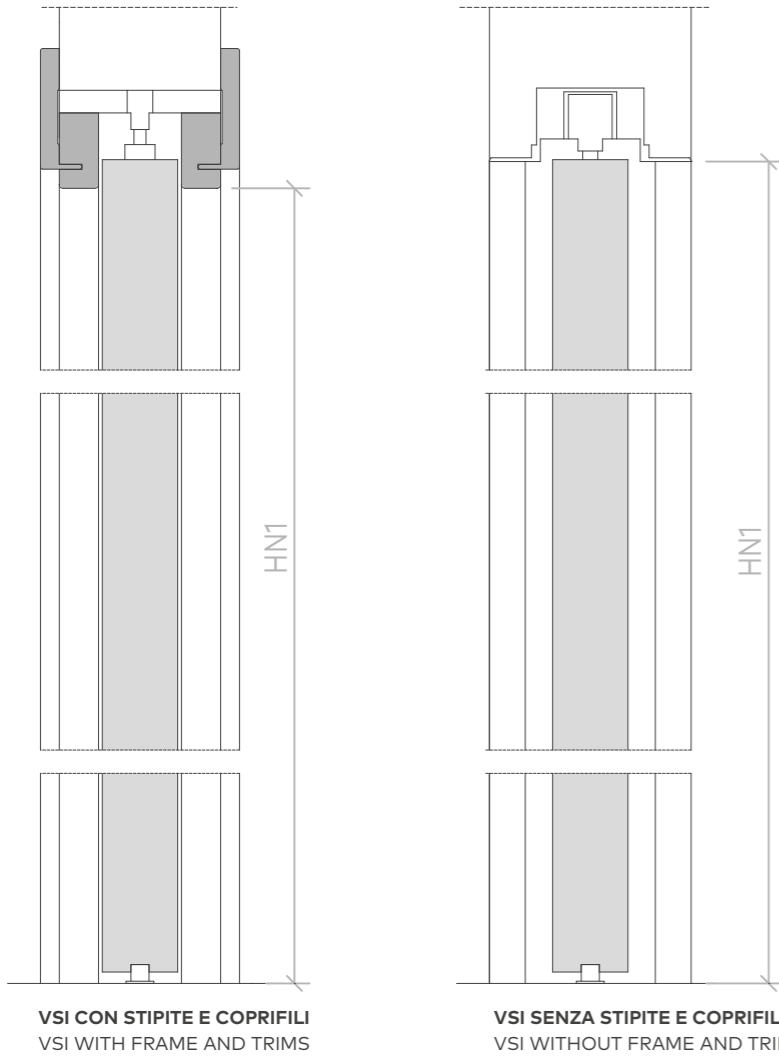

Sezione orizzontale Horizontal section

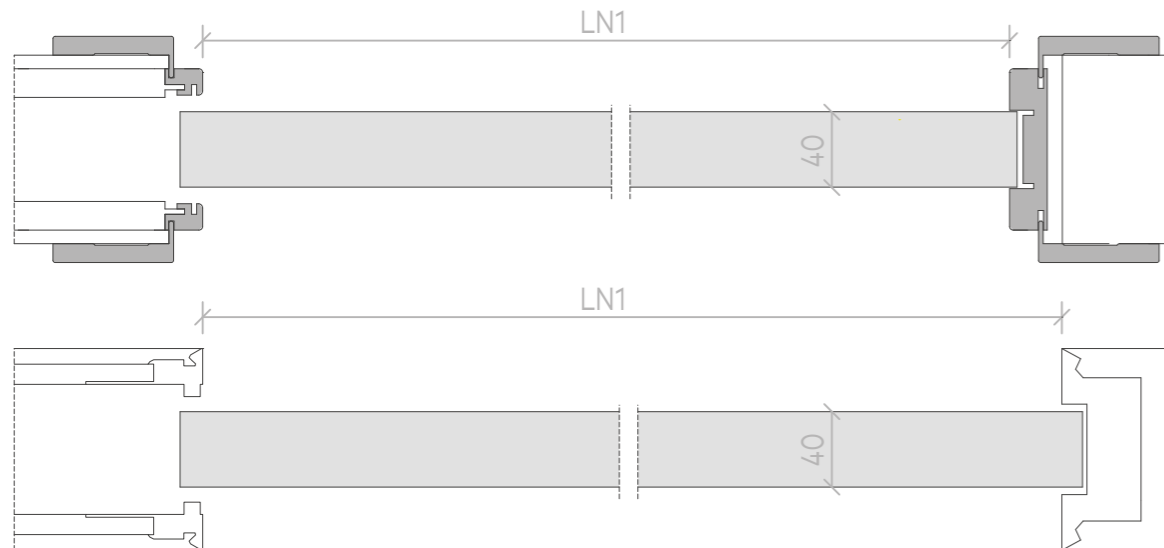

Sezione verticale Vertical section

VSI 2100 × 800 misure in mm
VSI 2100 × 800 measures in mm

HN1 ALTEZZA LUCE NETTA 1
HEIGHT REAL CLEAR OPENING 1

LN1 LARGHEZZA LUCE NETTA 1
WIDTH REAL CLEAR OPENING 1

Dimensioni variabili da progetto
Variable dimensions by project

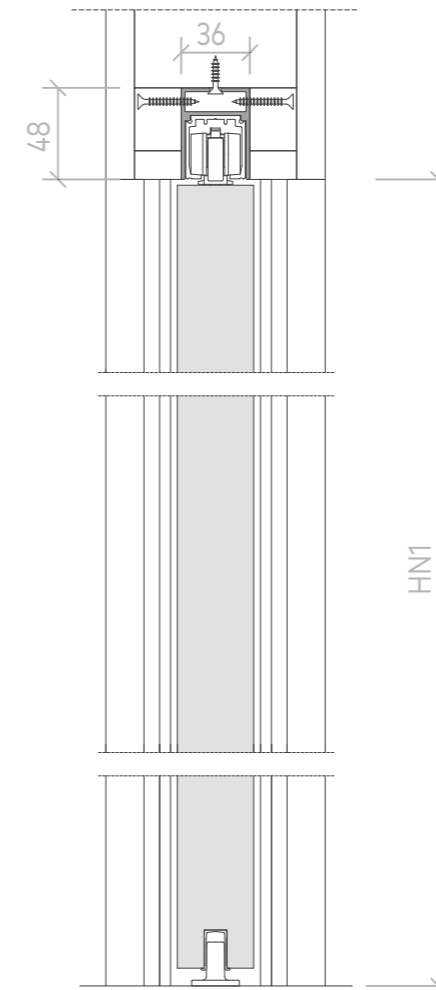

Sezione orizzontale Horizontal section

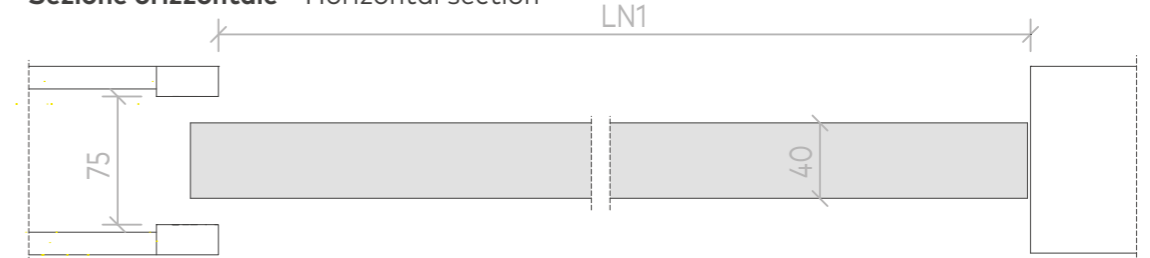

BINARIO A SOFFITTO CEILING TRACK

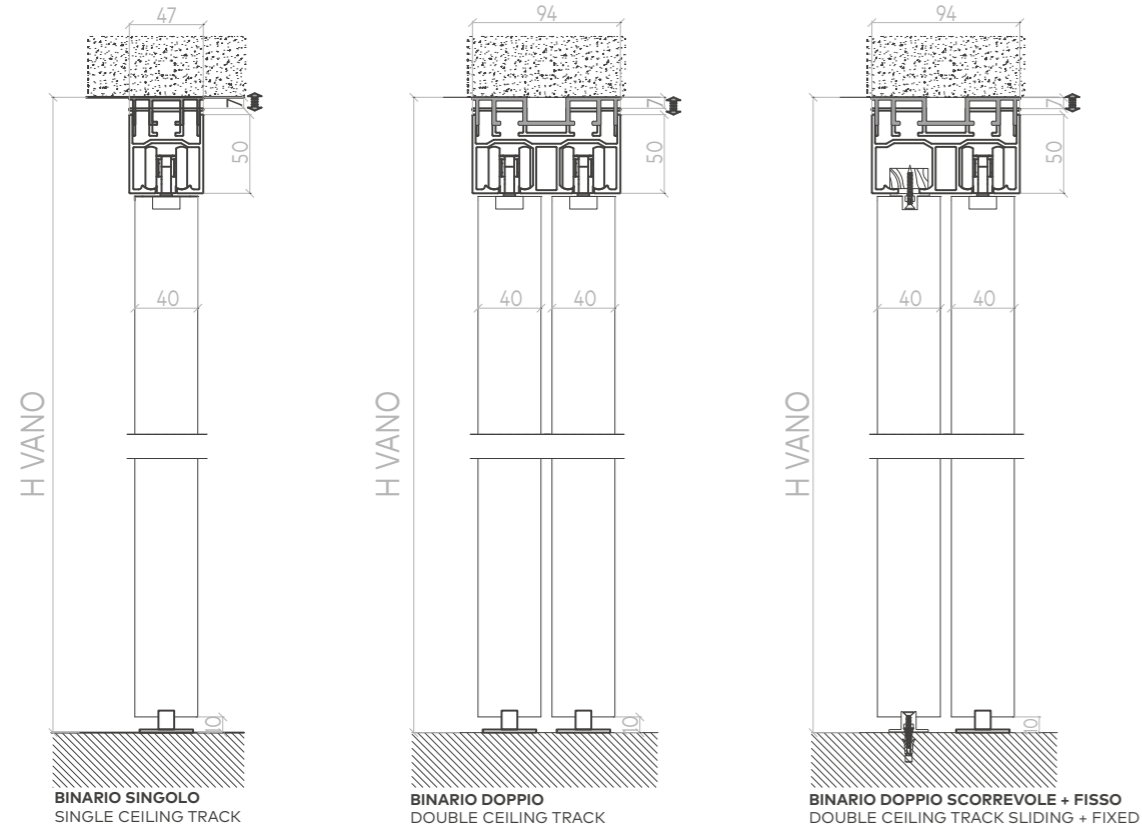

BINARIO A CONTROSOFFITTO CONCEALED TRACK

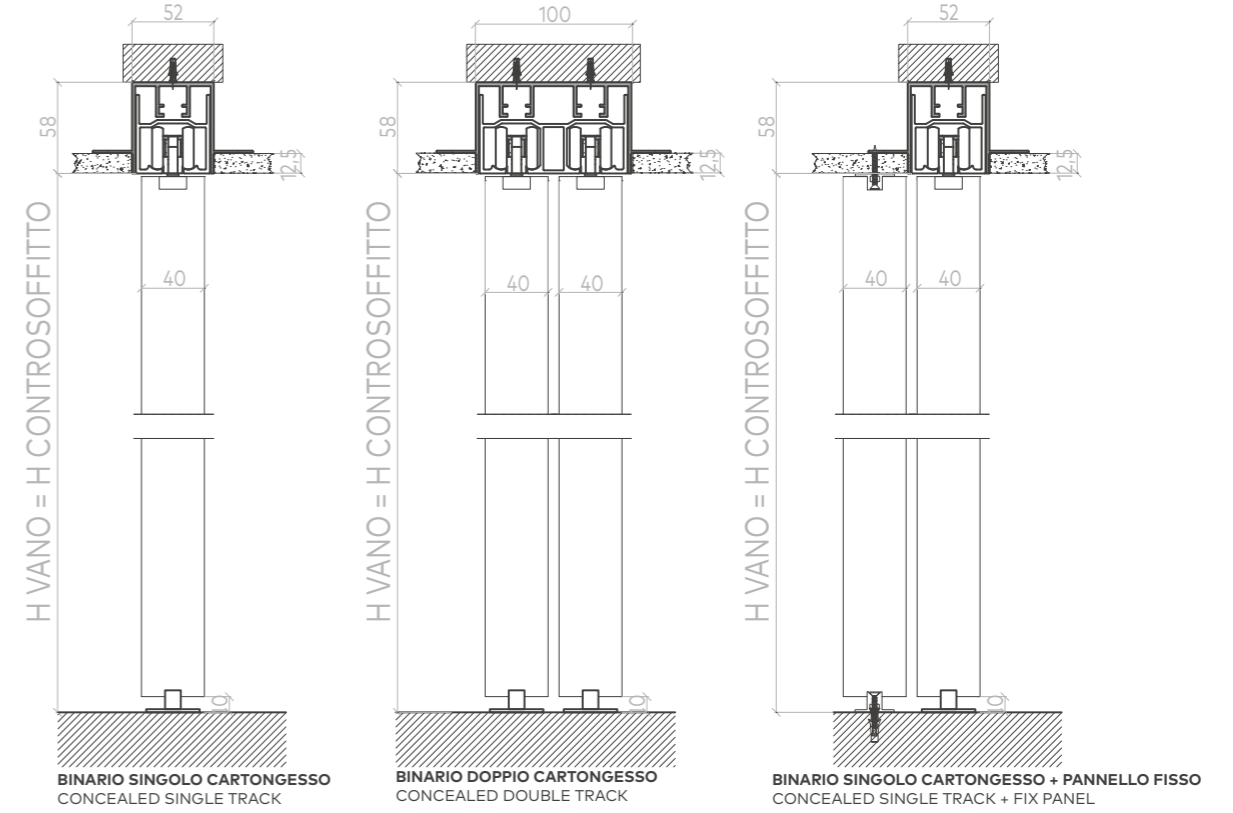

BINARIO A PARETE WALL TRACK

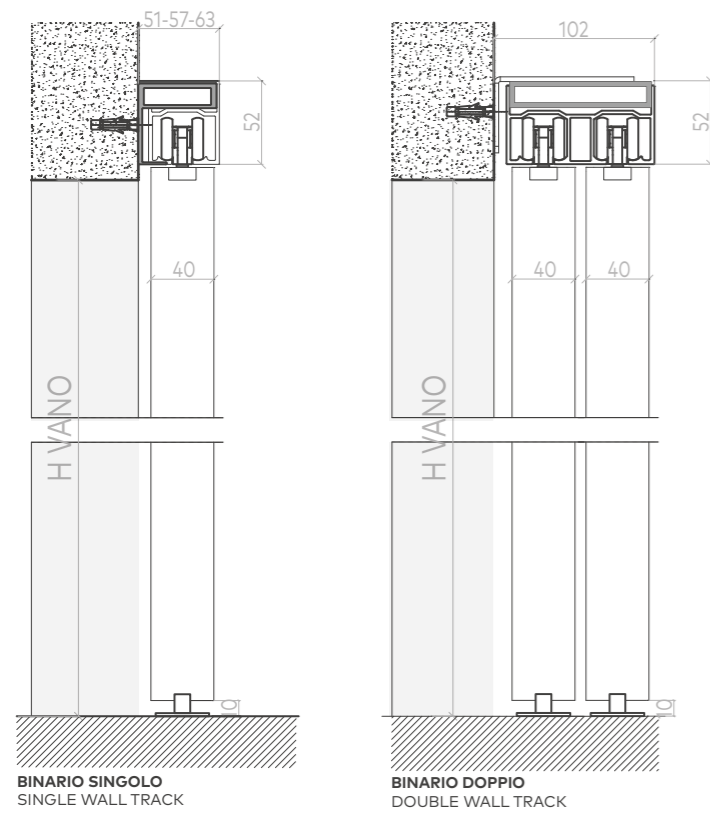

BINARIO A CONTROSOFFITTO A PARETE CONCEALED TRACK WALL

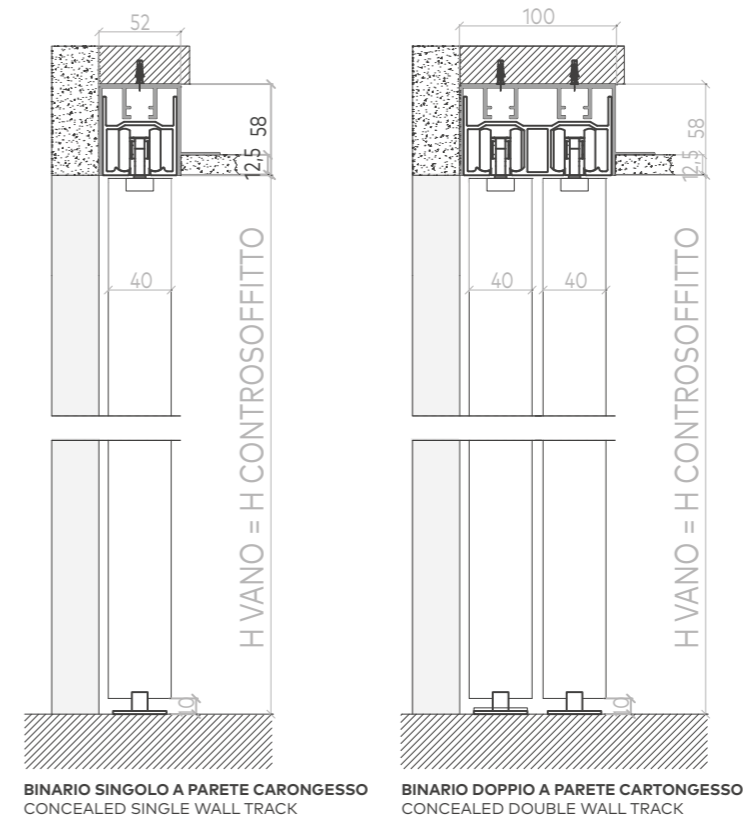



ENG



ITA

BINARIO A SOFFITTO CEILING TRACK

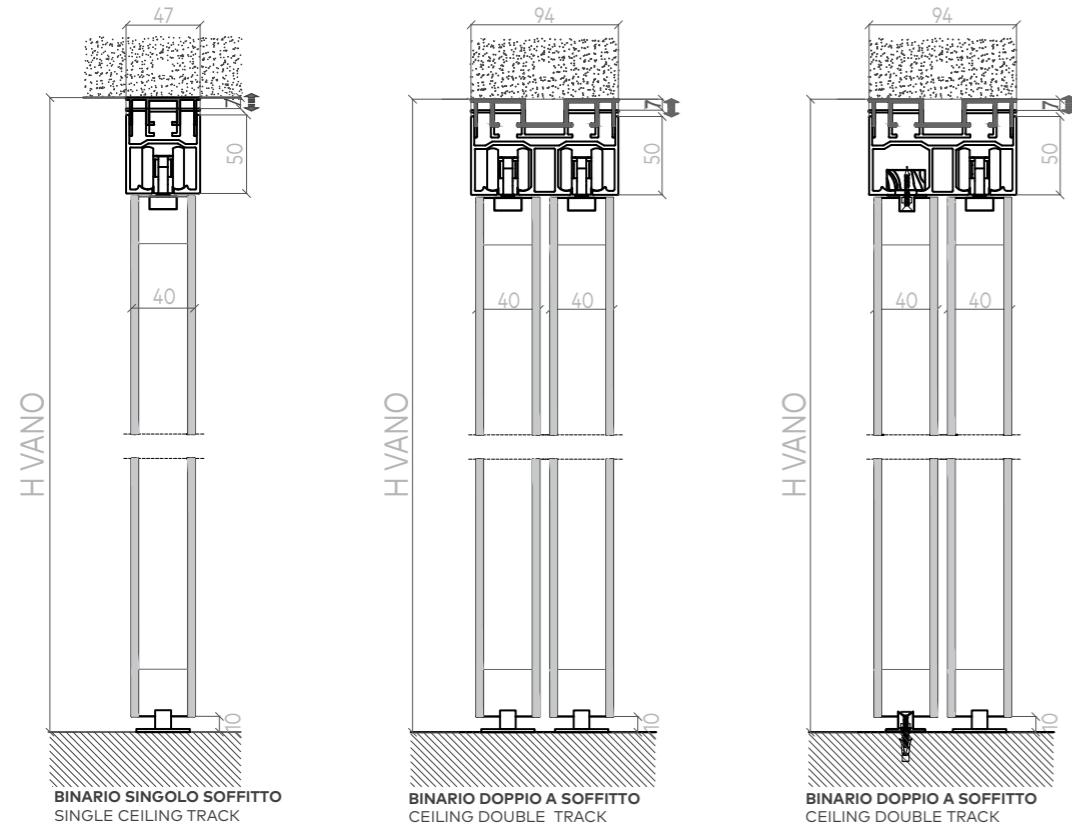

BINARIO A CONTROSOFFITTO CONCEALED TRACK

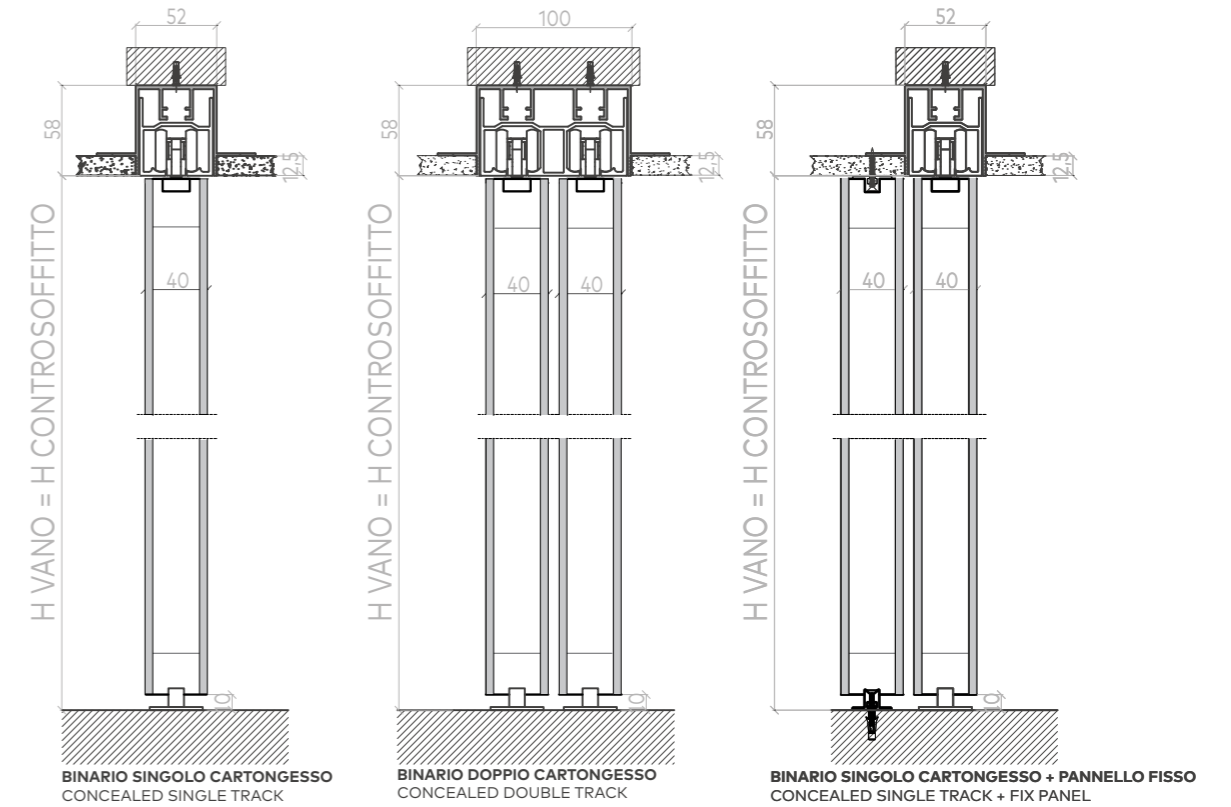

BINARIO A PARETE WALL TRACK

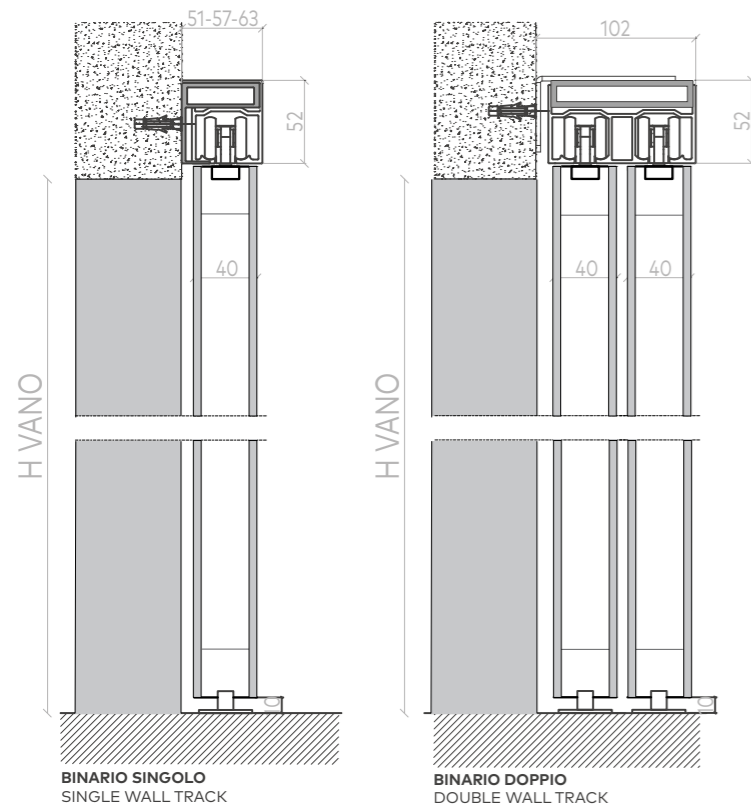

BINARIO A CONTROSOFFITTO A PARETE CONCEALED TRACK WALL

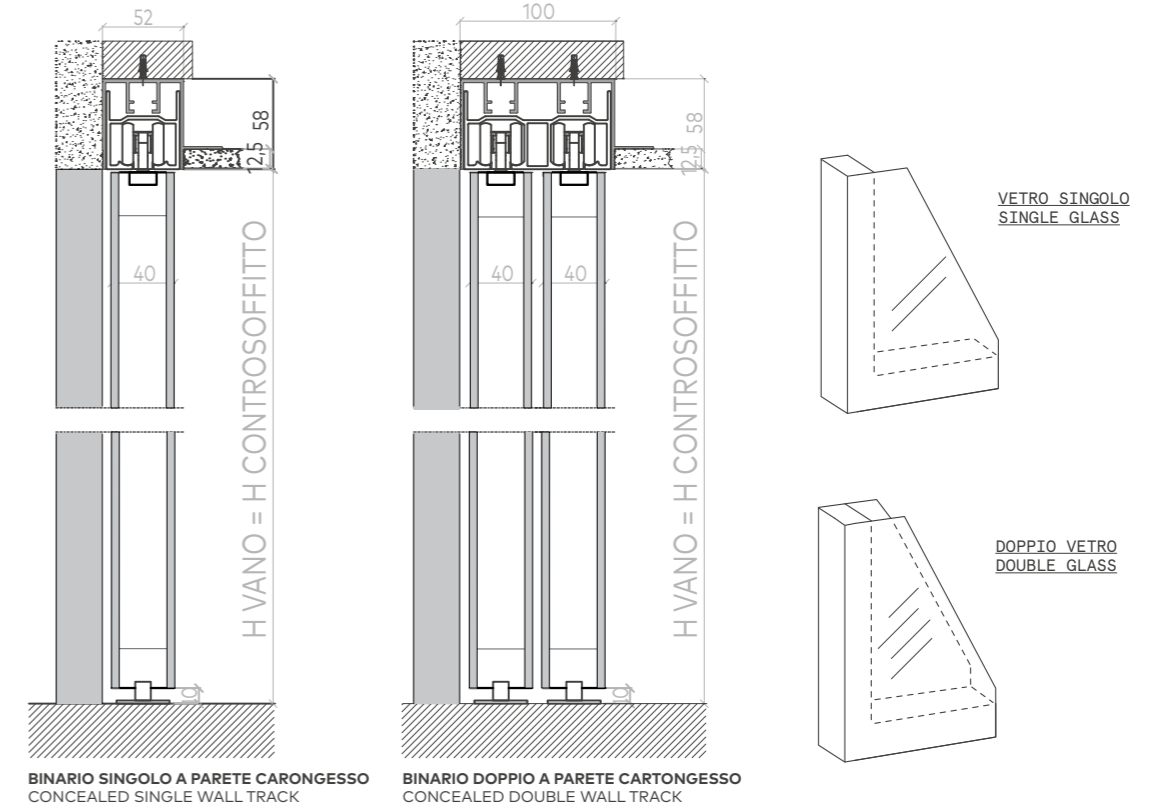

Bellagio Scorrevole, Bella, Collage, Mosaico, Industrial, Vertical, Mondrian, Linee

Track for brickwall (ceiling fixing)
/ Binario fissaggio muratura (fissaggio a soffitto)



SCHEDA TECNICA (DIMENSIONI IN MM)
TECHNICAL (DIMENSIONS IN MM)

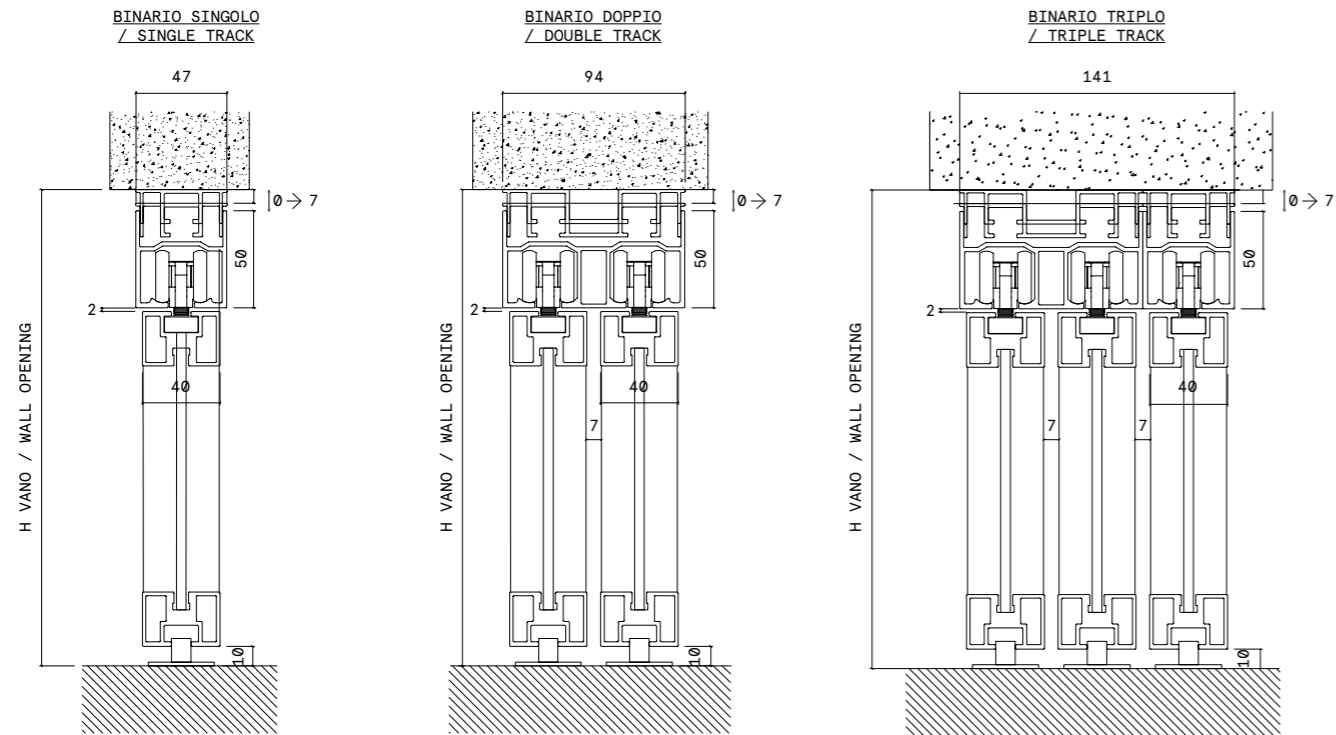

Fissaggio a soffitto con controsoffitto
Ceiling fixing with false ceiling

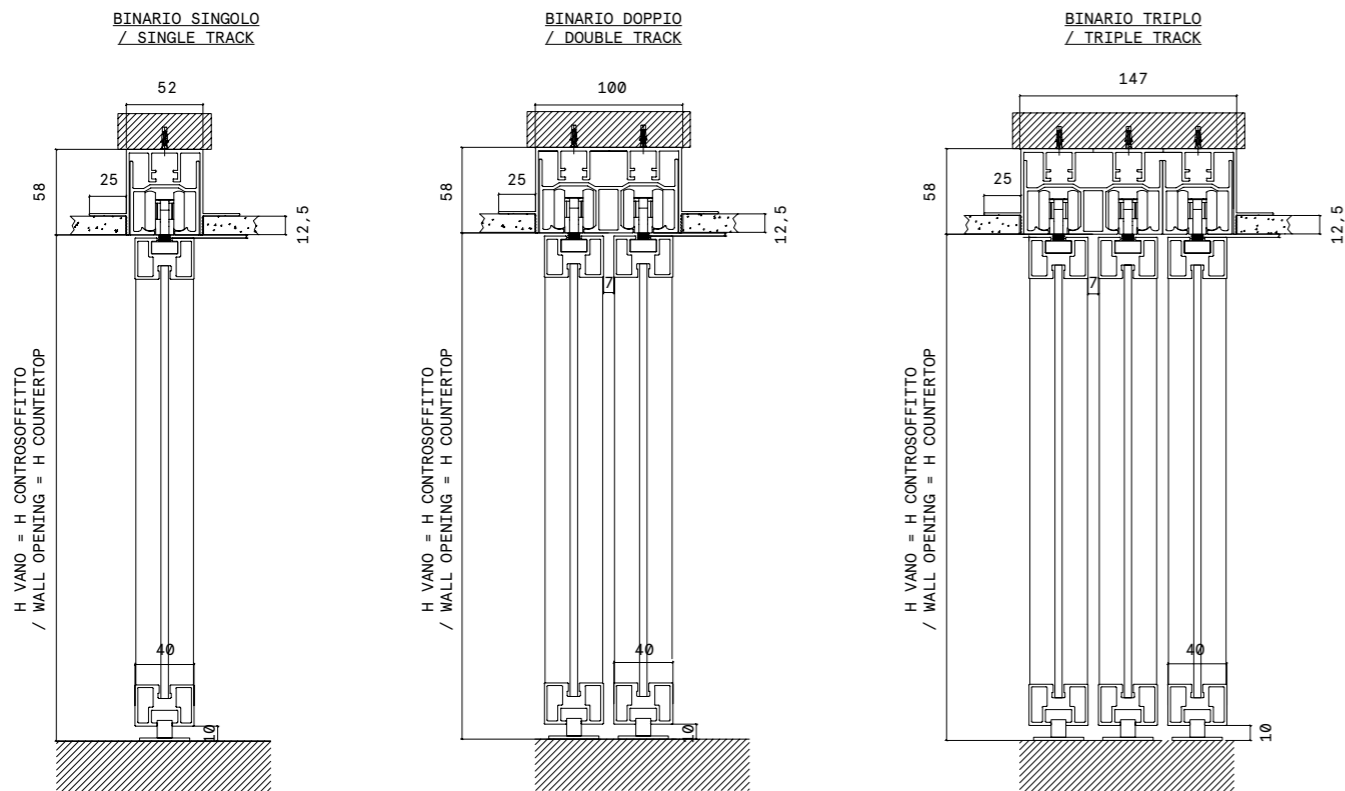

Track for brickwall (wall fixing)
/ Binario fissaggio muratura (fissaggio a parete)

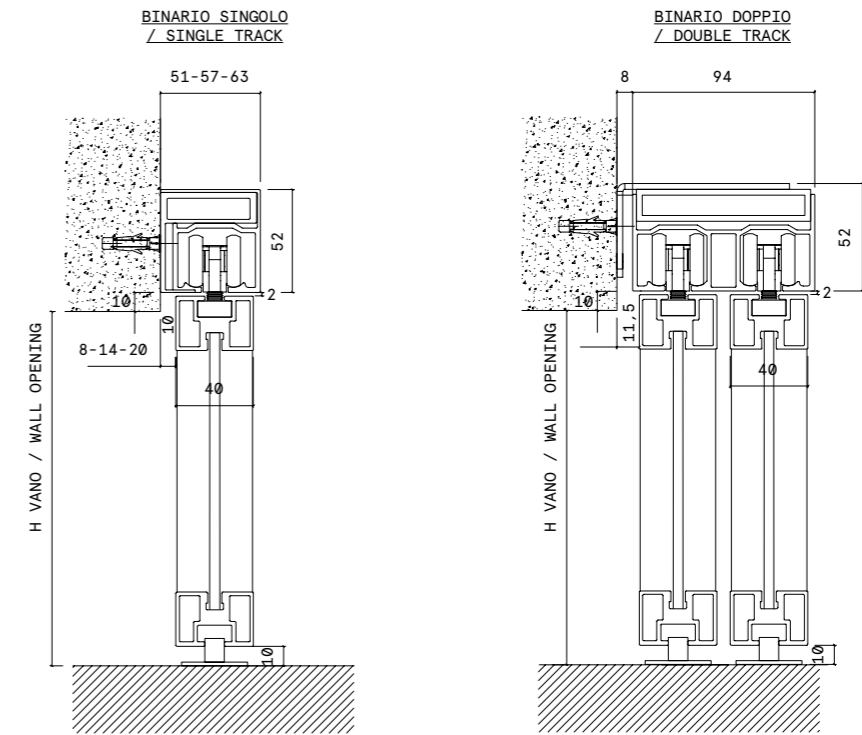

Fissaggio a parete con controsoffitto
Wall fixing with false ceiling

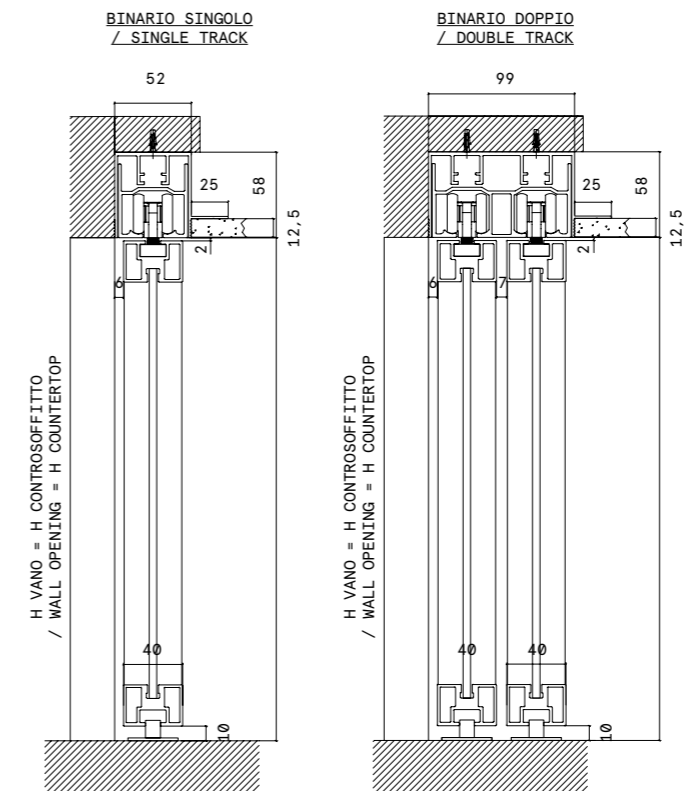



Track for brickwall / Binario fissaggio muratura

SCHEDA TECNICA (DIMENSIONI IN MM)
TECHNICAL (DIMENSIONS IN MM)

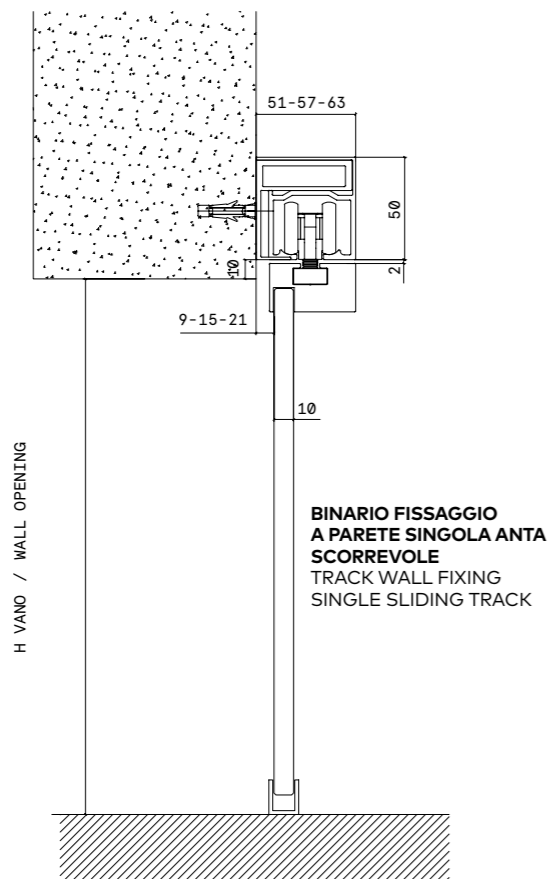
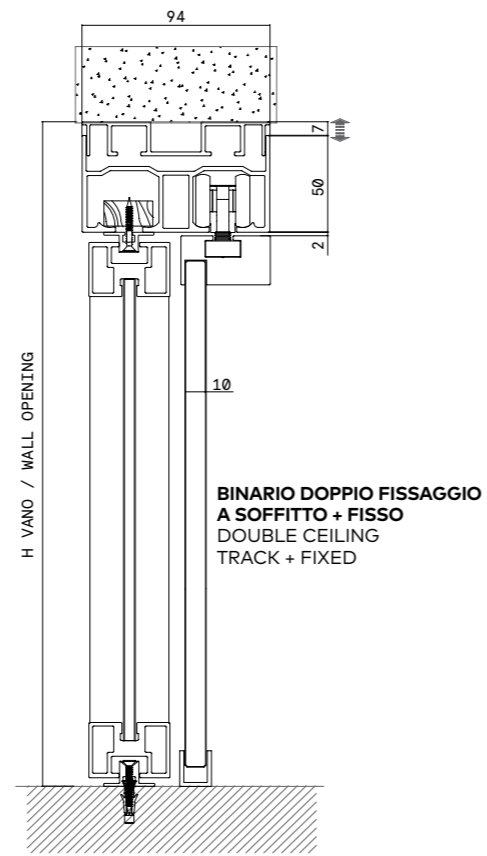
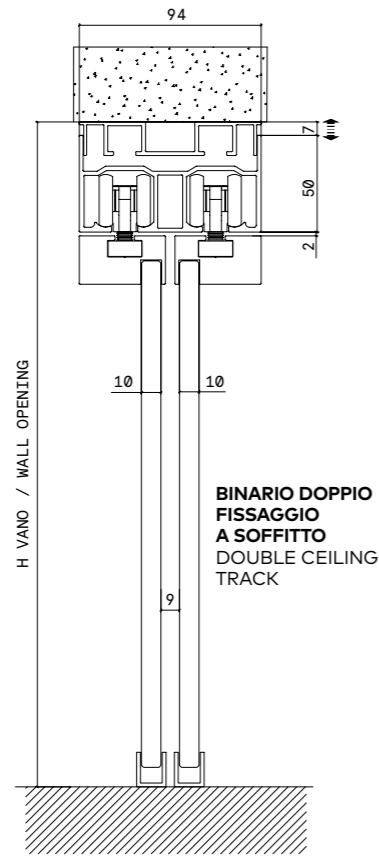
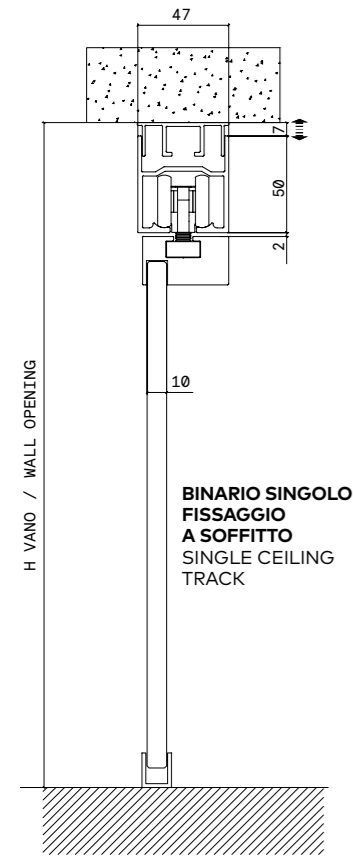

Track for plasterboard / Binario fissaggio cartongesso

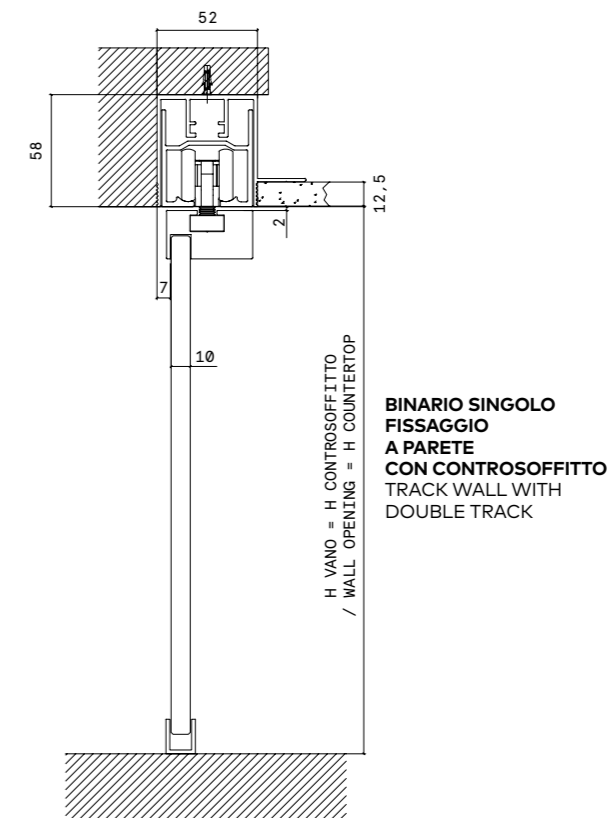
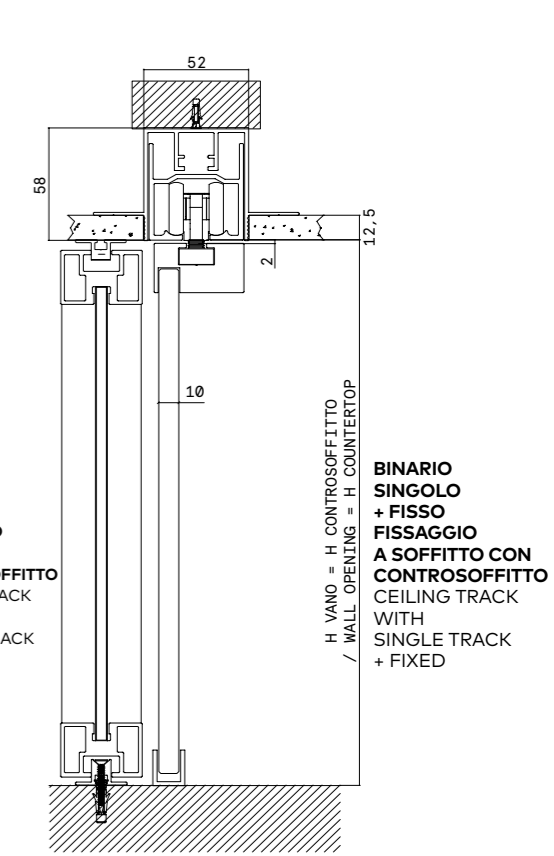
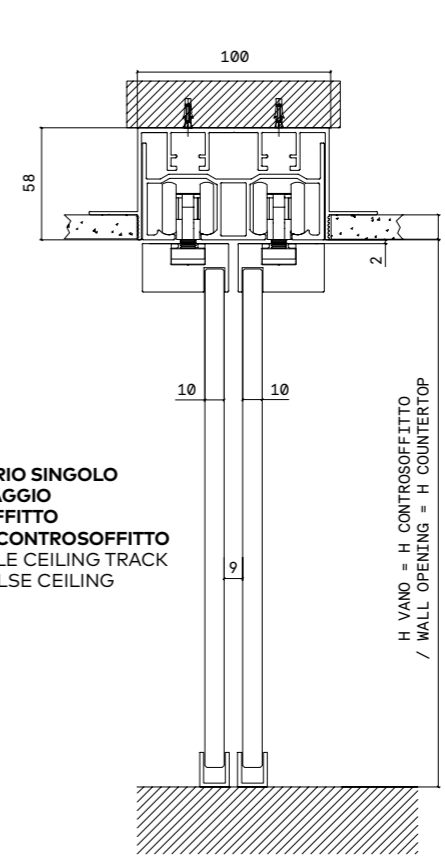
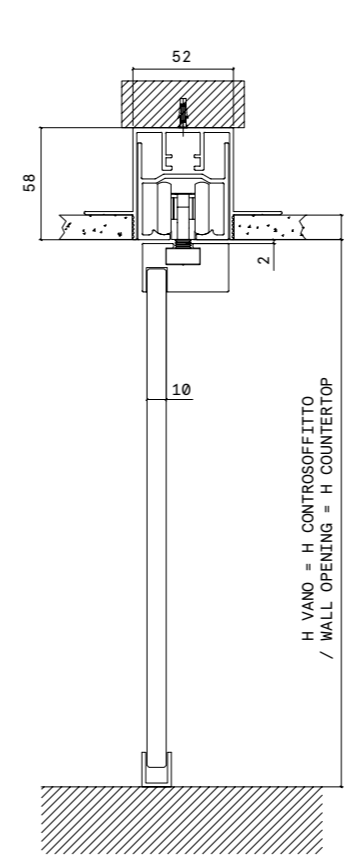

Sezione verticale Vertical section

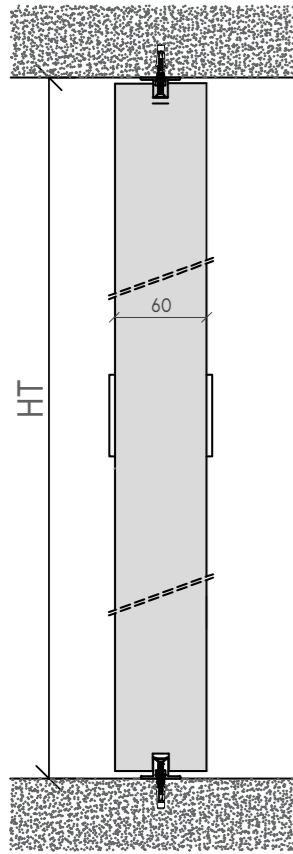

HT ALTEZZA VANO FINITO
HEIGHT FINISHED WALL OPENING

HT LARGHEZZA VANO MURO FINITO
WIDTH FINISHED WALL OPENING

Sezione verticale Vertical section

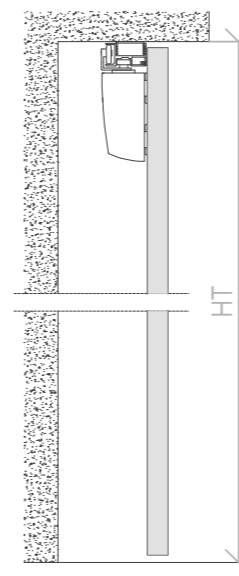

HT ALTEZZA VANO FINITO
HEIGHT FINISHED WALL OPENING

HT LARGHEZZA VANO MURO FINITO
WIDTH FINISHED WALL OPENING

Sezione orizzontale Horizontal section

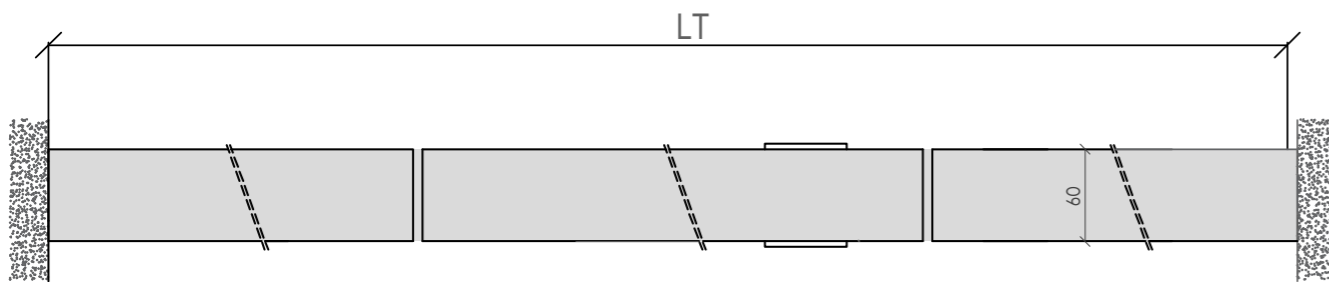
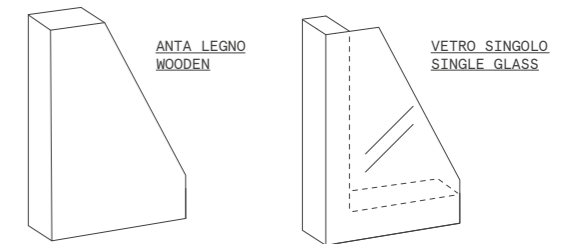
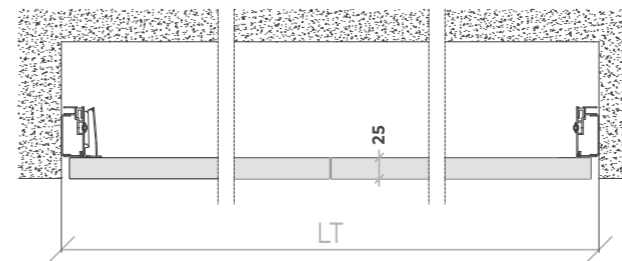

Esempi di composizione Composition examples

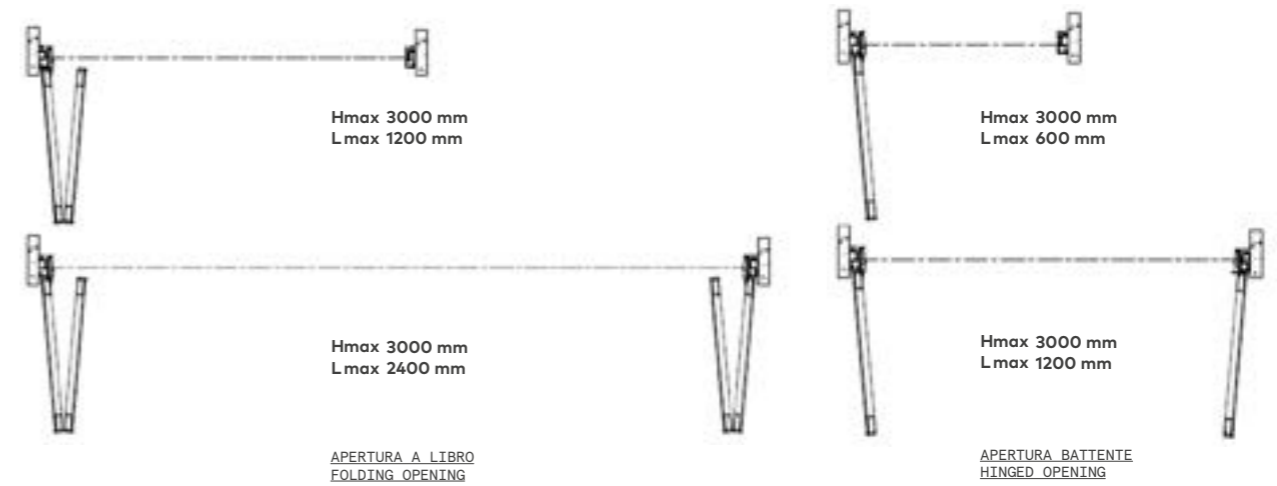

APERTURA A RIBALTA / HINGED OR TOP HUNG OPENING

VETRO / GLASS



VERSO L'ALTO / TOP HUNG OPENING



VERSO IL BASSO / BOTTOM HINGED OPENING

MANO DI FONDO / TO BE PAINTED

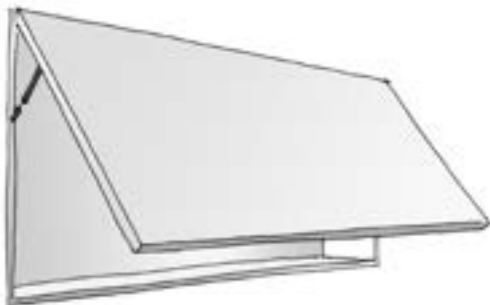

VERSO L'ALTO / TOP HUNG OPENING



VERSO IL BASSO / BOTTOM HINGED OPENING

APERTURA A BATTENTE / HINGED OPENING

VETRO / GLASS

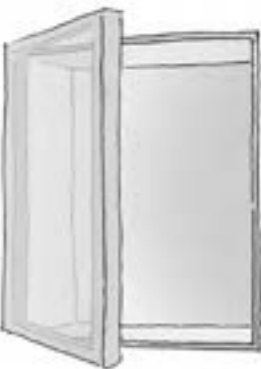

SINISTRA / LEFT

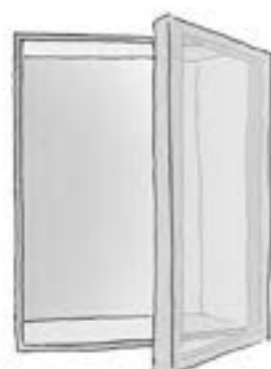

DESTRA / RIGHT

MANO DI FONDO / TO BE PAINTED



SINISTRA / LEFT

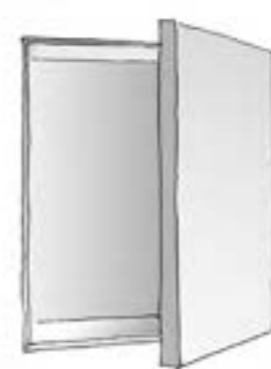

DESTRA / RIGHT

DIMENSIONI / DIMENSIONS

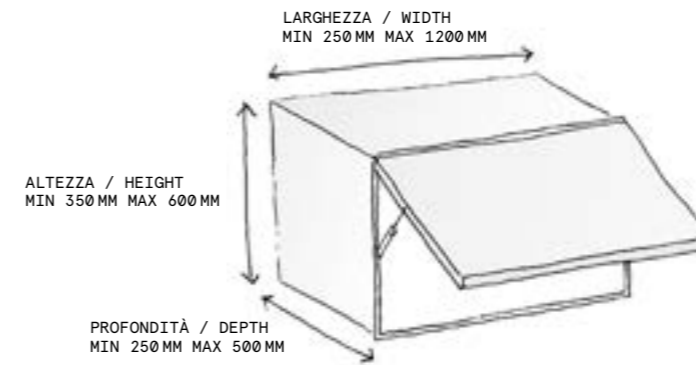

LARGHEZZA / WIDTH
MIN 250MM MAX 600MM

ALTEZZA / HEIGHT
MIN 250MM MAX 1800MM

PROFONDITÀ / DEPTH
MIN 250MM MAX 500MM

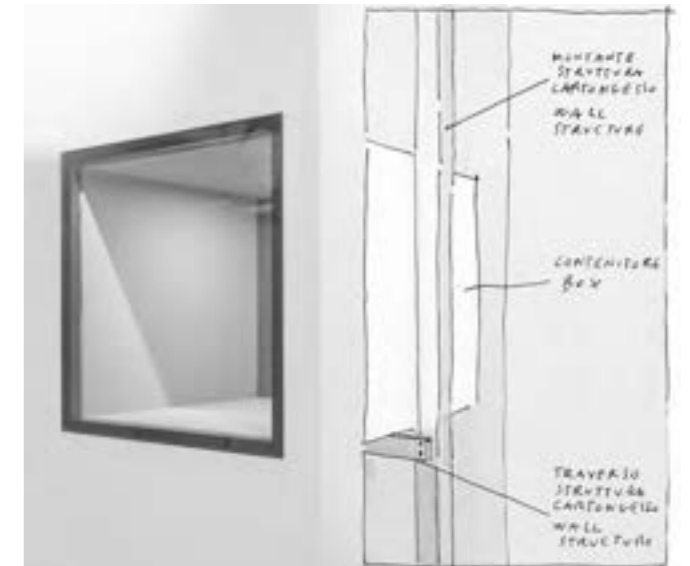

The container box is produced with depth at the centimeter, adapting to the project needs. The insertion inside the wall is easy and quick, guaranteeing a perfect aesthetic and technical result.

Il contenitore viene realizzato con profondità al centimetro, secondo le esigenze progettuali. L'inserimento nella struttura della parete è semplice e veloce, garantendo un perfetto risultato estetico e tecnico.

COMPOSIZIONI / COMPOSITIONS

2 ANTE / PANELS



3



4



5



6



Creative direction & Photography
Marco Brienza / Sfelab

Interior & Styling
Davide Casali

Digital visual
Il Magma
Alessandro Consonni
Sfelab

Copywriting
Valentina Dalla Costa

Graphic project
Sfelab

Postproduction & Pre press
Sfelab

*Le informazioni, le immagini
e le finiture presenti nel
catalogo sono da considerarsi
indicative e non vincolanti*

*/ Information, images and
the finishes present in the
catalog are to be considered
indicative and non-binding*



VIVA S.r.l.

via Matteotti 37
23891 Barzanò (LC) ITALY
T: +39 039 921 7388
E: viva@vivaporte.com
W: www.vivaporte.com

Viva Social
Facebook: [vivaporte](#)
Twitter: [vivaporte](#)
Instagram: [vivaporte](#)
Youtube: [Viva Porte](#)